

Model 1095A/C

Industrial GPS Clock

Operation Manual

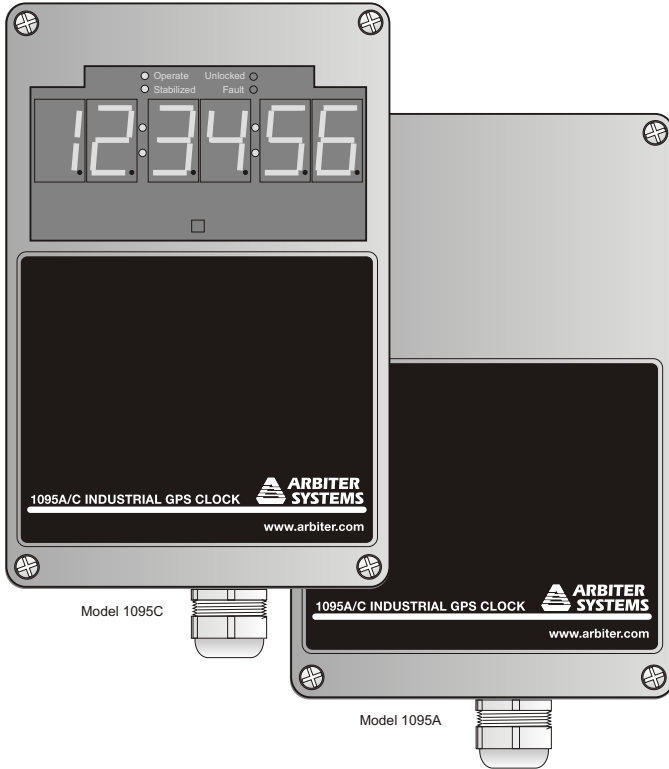

Arbiter Systems, Inc.
Paso Robles, CA 93446
U.S.A.
www.arbiter.com

Description

This manual is issued for reference only, at the convenience of Arbiter Systems. Reasonable effort was made to verify that all contents were accurate as of the time of publication. Check with Arbiter Systems at the address below for any revisions made since the original date of publication.

Contact Information

Arbiter Systems, Inc.
1324 Vendels Circle, Suite 121
Paso Robles, CA 93446
(805) 237-3831
Website: www.arbiter.com
techsupport@arbiter.com
sales@arbiter.com

What This Manual Covers

This manual describes the operation and configuration of the Model 1095A/C Industrial GPS Clock.

Current Firmware Date

This version of the manual is written for clocks having a firmware date of 12 December 2011 or later. Any changes made in subsequent revisions which affect operation or specifications will be noted with either (a) a new manual or (b) a revised version of this manual. To display the firmware date for your instrument, connect to the unit with the 1095 Utility Application, also called the *1095 Utility*. It displays the firmware version in the System tab under "Misc." To obtain the 1095 Utility, see Section 4.2. Alternatively, using the "VE" command via the RS-232C port, the firmware date would be returned as DD MMM YYYY (e.g. 12 Dec 2011) – see Section 8.11.3.

Firmware Updates

Firmware updates are available to customers by download from the Arbiter website. For additional information, contact Arbiter Systems at the numbers listed above under "Contact Information". Where applicable, this update may include new documentation, such as a new version of this manual.

LIMITED WARRANTY

Arbiter Systems makes no warranty, expressed or implied, on any product manufactured or sold by Arbiter Systems except for the following limited warranty against defects in materials and workmanship on products manufactured by Arbiter Systems.

Products manufactured by Arbiter Systems are guaranteed against defective materials and workmanship under normal use and service for ten (10) years from date of delivery. The responsibility of Arbiter Systems under this warranty is limited to repair or replacement, at Arbiter Systems' option, of any product found to be defective. Arbiter Systems shall have no liability under this warranty unless it receives written notice of any claimed defect, within the warranty period.

For warranty service or repair, products must be returned to a service facility designated by Arbiter Systems. Buyer shall prepay all shipping charges, duties, and taxes to send the product to Arbiter Systems and Buyer shall prepay shipping charges, duties, and taxes to return the product to Buyer.

THE WARRANTY SET FORTH HEREIN CONSTITUTES THE ONLY WARRANTY OBLIGATIONS OF ARBITER SYSTEMS, EXPRESSED OR IMPLIED, STATUTORY, BY OPERATION OF LAW, OR OTHERWISE. ARBITER SYSTEMS DISCLAIMS ANY WARRANTY OF MERCHANTABILITY OR FITNESS FOR A PARTICULAR PURPOSE, AND BUYER EXPRESSLY WAIVES ALL OTHER WARRANTIES.

This limited warranty does not extend to any product, which has been subject to

1. Improper use or application, abuse, or operation beyond its rated capacity, or contrary to the instructions in the operation and maintenance manuals (if any);
2. Accident;
3. Repair or maintenance performed by Buyer, except in accordance with the operation and maintenance manuals, if any, and any special instructions of Arbiter Systems;
4. Modification without the prior written authorization of Arbiter Systems (whether by the substitution of non-approved parts or otherwise). The remedies provided herein are Buyer's sole and exclusive remedies. In no event shall Arbiter Systems be liable for direct, indirect, incidental or consequential damages (including loss of profits), whether based on contract, tort, or other legal theory.

FOR THE FASTEST POSSIBLE SERVICE, PLEASE PROCEED AS

FOLLOWS:

1. Notify Arbiter Systems, Inc., specifying the instrument model number and serial number and giving full details of the difficulty. Service data or instrument-return authorization will be provided upon receipt of this information.
2. If instrument return is authorized, forward prepaid to the manufacturer. If it is determined that the instrument is not covered by this warranty, an estimate will be made before the repair work begins, if requested.

See Contact Information on page ii.

Model 1095A/C Industrial GPS Clock Operation Manual

Chapter 1	Unpacking
Chapter 2	Mounting and Wiring
Chapter 3	GPS Reception
Chapter 4	Startup & Configuring
Chapter 5	Timing Signals – IRIG-B & Event Inputs
Chapter 6	Specifications
Chapter 7	Using External Antennas
Chapter 8	Serial Command Reference
Appendix A	Conformity with European Union Directives (CE Mark)
Appendix B	Statement of Compliance
Index	

Copyright ©Arbiter Systems Incorporated November 2025. All rights reserved. Published by Arbiter Systems, Inc.

PD0039700Q

Contents

1	Introduction	1
1.1	Unpacking	1
1.2	Included Items	2
1.2.1	Model 1095A/C with Internal Antenna	2
1.2.2	Model 1095A/C with External Antenna	2
1.3	Optional Accessories	2
1.3.1	Initial Programming and Setup Notes	2
1.4	Component Identification	3
1.4.1	Model 1095A with Internal Antenna	3
1.4.2	Model 1095C with Internal Antenna	4
1.4.3	Model 1095A with External Antenna	5
1.4.4	Model 1095C with External Antenna	6
1.4.5	Clocks with Internal GPS Antenna	7
1.4.6	Clocks with External GNSS Antenna	7
1.4.7	Precautions	7
1.5	Model 1095A/C Clock Mounting Kit	7
1.6	Overview of Enclosure	7
1.7	Programming Cable Kit	8
2	Mounting and Wiring	9
2.1	Enclosure	9
2.2	Enclosure/Cover Seal	9
2.3	Sealing Cable Port	10
2.4	Mounting the External GNSS Antenna	10
2.5	Display	10
2.6	Installing the Mounting Tabs	10
2.7	Connecting Input & Output Wiring	11
2.7.1	Internal Antenna Operation	11
2.7.2	Optional External Antenna	12
2.7.3	Installing Main Wiring	12

2.7.4	Signal Connections and Controls	13
2.7.5	Fuse	15
2.7.6	Inlet Power	15
2.7.7	Verifying Communication	15
3	GPS Reception	16
3.1	Basic Setup	16
3.1.1	Antenna Operation	17
3.1.2	Mounting Locations	17
3.2	Using an External Antenna	19
3.2.1	External GNSS Antenna, Option 01	19
3.2.2	Using the Grounding Block	19
3.2.3	Technical Details on External Antennas	19
3.2.4	Mounting an External Antenna	20
3.2.5	Optional Antenna Mounting Kit	20
4	Startup & Configuring	22
4.1	Startup	22
4.1.1	Model 1095A Startup	23
4.1.2	Model 1095C Startup	24
4.1.3	Model 1095A Fault Display	25
4.1.4	Model 1095C Fault Display	25
4.2	1095 Utility Application	26
4.2.1	Establishing a Serial Connection	27
4.2.2	Reading Clock Configuration	29
4.2.3	The System Screen	30
4.2.4	The Communication Screen	32
4.2.5	The Time Screen	33
4.2.6	The IRIG-B Screen	34
4.2.7	The Programmable Pulse A Screen	35
4.2.8	The Programmable Pulse B Screen	36
4.2.9	The Display Screen	37
4.2.10	Saving a Configuration File	38
4.2.11	Uploading a Configuration	38
4.3	Using Terminal Emulation Programs	39
4.3.1	Using HyperTerminal	39
4.3.2	Using Tera Term Pro	40
5	Timing Signals – IRIG-B and Event Triggering	41
5.1	Introduction	41
5.2	Timing Output Description	42
5.2.1	Standard Inputs and Outputs	43
5.2.2	Digital Drivers	43

5.2.3	Analog Drivers	43
5.3	Output Signal Description	44
5.3.1	IRIG-B Description	44
5.3.2	Modulated and Unmodulated IRIG-B	45
5.3.3	IRIG-B IEEE 1344 Extension	46
5.3.4	1 Pulse Per Second (1 PPS)	46
5.3.5	Programmable Pulse (Prog. Pulse)	46
5.4	Connecting Outputs	47
5.4.1	Wiring to Screw Terminals	47
5.4.2	How Far Can I Run IRIG-B Cabling?	47
5.4.3	Synchronizing Multiple IED's	48
5.4.4	Connecting Unmodulated IRIG-B	48
5.4.5	Connecting Modulated IRIG-B	49
5.4.6	Wire Losses	49
5.4.7	Voltage Matching for Modulated IRIG-B	50
5.4.8	Cable Delays	50
5.5	Input Signal Timing	51
5.5.1	Event Timing – Latency	52
5.5.2	Deviation Measurement	52
5.5.3	Deviation Measurement Principle	52
5.5.4	Connecting Input Signals	53
5.5.5	Setting Event Channel Time	53
5.5.6	Configuring for Event or Deviation Recording	53
5.5.7	Accessing Data	53
5.5.8	Broadcasting Event Data	53
5.5.9	Status of Event or Deviation	54
5.5.10	Clearing Event Records	54
6	Specifications	55
6.1	Introduction	55
6.2	Receiver Characteristics	55
6.2.1	Timing Accuracy	55
6.2.2	Position Accuracy	55
6.2.3	Satellite Tracking	56
6.2.4	Acquisition	56
6.3	I/O Configuration	56
6.3.1	Outputs	56
6.3.2	Programmable Pulse Output	56
6.3.3	Relay Contacts	58
6.4	Interface	58
6.4.1	Operator	58
6.4.2	System	58

6.4.3	Suggestions for Main Wiring	59
6.4.4	Sealing Cable Port Specifications	60
6.5	Power Requirements	62
6.5.1	Standard	62
6.6	General	62
6.6.1	Physical	62
6.6.2	Environmental	62
6.6.3	Certification and Approvals	62
7	External Antenna, Technical Details	63
7.1	Antenna Cable	63
7.1.1	Length and Loss Considerations	63
7.1.2	Effects of Cable Parameters	63
7.1.3	Cable Delay	64
7.1.4	Attenuation	64
7.1.5	DC Resistance	64
7.1.6	Accessories for Longer Cable Runs	65
7.1.7	Physical Protection	65
7.1.8	Adjacent Signals	66
7.1.9	Antenna Power	66
7.1.10	Cable Connection to External Antenna	66
7.1.11	Cable Connection to Clock	66
7.1.12	User-Supplied Antenna Cables	66
7.1.13	External Antenna-Clock-Cable Testing	67
7.2	GNSS Surge Arrester Kit	67
7.2.1	Description	67
7.2.2	Functions	67
7.2.3	Installation	68
7.2.4	Physical Dimensions	69
8	Serial Command Reference	70
8.1	Introduction	70
8.2	Serial Communication Definitions	71
8.2.1	Broadcast String Overview	72
8.2.2	String Setup Examples and Tutorial	74
8.2.3	Preconfigured Broadcast Strings	78
8.2.4	Com Port Settings	81
8.3	Broadcast Commands	82
8.3.1	Broadcast Mode – Interrogate	82
8.3.2	Broadcast Mode – Start Configured String	82
8.3.3	Broadcast Mode – Event	82
8.4	Event Mode Commands	83

8.4.1	Return Specific Event	83
8.4.2	Set Event Channel Time	83
8.4.3	Control Event Operation	83
8.4.4	Return Deviation for Event Channel	83
8.5	Status Mode Commands	84
8.5.1	Status of Event/Deviation	84
8.5.2	Clock Status	84
8.5.3	EEPROM Status	84
8.5.4	Receiver Status	85
8.5.5	Time Quality	85
8.5.6	Fault Message	85
8.6	Time Adjustment Commands	86
8.6.1	Return DST Settings	86
8.6.2	Set DST Mode	86
8.6.3	Set DST Auto Start Time	86
8.6.4	Set DST Auto Stop Time	87
8.6.5	Set Local Offset	87
8.6.6	Set Display Time Mode	87
8.7	IRIG Data, IEEE P1344	87
8.8	Position Data Commands	88
8.8.1	Return Elevation	88
8.8.2	Return Latitude	88
8.8.3	Return Longitude	88
8.8.4	Set Receiver Position	88
8.9	Date and Time Commands	89
8.9.1	Set Receiver Time	89
8.9.2	Return Local Date & UTC Date	89
8.9.3	Return Local Time & UTC Time	89
8.10	Programmable Pulse Commands	90
8.10.1	Set Pulse Width	90
8.10.2	Set Programmable Pulse Output Mode	90
8.10.3	Set Alarm Time Mark	90
8.10.4	Set Programmable Pulse-Mode Type	91
8.10.5	Set Programmable Pulse Delay	91
8.10.6	Set Pulse Polarity	91
8.10.7	Set Output Frequency	91
8.10.8	Set Time Selection	92
8.11	Miscellaneous Commands	92
8.11.1	Set Antenna Delay	92
8.11.2	Set Out-of-Lock Time	92
8.11.3	Return Firmware Version	92
8.11.4	Select Survey Mode	93

8.11.5 Set Relay Output Mode	93
8.11.6 Set RS-485 Data Output Mode	93
8.11.7 Set Display Mode	93
A CE Mark Declaration	94
B Statement of Compliance	96

List of Figures

- 1.1 Model 1095A Front Panel, with Internal Antenna 3
- 1.2 Model 1095C Front Panel, with Internal Antenna 4
- 1.3 Model 1095A Front Panel, with Antenna Connector 5
- 1.4 Model 1095C Front Panel, with Antenna Connector 6
- 1.5 Model 1095A/C Mounting Kit 8

- 2.1 Model 1095A/C Mounting Tabs, Attached 11
- 2.2 Connector Block Wiring 12

- 3.1 Model 1095A/C Mounting Situation 18
- 3.2 Grounding Block 19
- 3.3 Antenna Assembly for Mounting 20
- 3.4 Antenna Mounting Bracket 21
- 3.5 Antenna Mounting with AS0044600 Kit 21

- 4.1 Model 1095A Startup Displays 23
- 4.2 Model 1095C Startup Displays 24
- 4.3 Model 1095A with Startup Fault 25
- 4.4 Model 1095C with Startup Fault 25
- 4.5 1095 Utility Application, Opening Window 26
- 4.6 Connecting with the Model 1095A/C 28
- 4.7 Reading the Configuration 29
- 4.8 Reading the System Screen 30
- 4.9 Clearing Events 31
- 4.10 Communication Settings 32
- 4.11 Time Adjustment Screen 33
- 4.12 IRIG-B Adjustment Screen 34
- 4.13 Programmable Pulse A Setup 35
- 4.14 Programmable Pulse B Setup 36
- 4.15 Display Control 37
- 4.16 HyperTerminal Window, Port Settings 39

4.17 Tera Term Pro Window, COM Port Selection	40
5.1 Connector Terminals	42
5.2 IRIG-B Waveforms	45
6.1 Sealing Cable Port	60
7.1 GNSS Surge Arrester	67
7.2 Suggested Mounting of the GNSS Surge Arrester	68

List of Tables

- 2.1 COM1 Dip Switches (*Factory default) 14
- 3.1 Antenna Mounting Kit, Parts List 20
- 5.1 Drive Current vs. Voltage 43
- 5.2 IRIG-B Time Code, Types Available 44
- 5.3 Programmable Pulse Modes 47
- 6.1 Temperature and Humidity List 62
- 7.1 GPS Cable Data and Accessory Information 65
- 8.1 Characters used with Custom Strings 73
- 8.2 Short Table of ASCII Characters 77

Chapter 1

Introduction

This section introduces the Model 1095A/C Industrial GPS Clock and covers unpacking the Model 1095A/C, identifying components and accessories.

The Model 1095A/C may be ordered in four different configurations.

- Model 1095A with internal antenna (see Section 1.4.1)
- Model 1095C with internal antenna (see Section 1.4.2)
- Model 1095A with external antenna (see Section 1.4.3)
- Model 1095C with external antenna (see Section 1.4.4)

The following information will assist you with identifying components and accessories for each of the four configurations.

1.1 Unpacking

While the clock is housed in a rugged case intended for outdoor use, handle carefully, especially during setup while the cover is removed. Some of the components are sensitive to shock and static electricity. After opening the shipping container, you will find four M4 screws securing the cover to the case. For access to wiring and programming, you will need to remove these screws.

1.2 Included Items

1.2.1 Model 1095A/C with Internal Antenna

- Model 1095A/C Industrial GPS Clock
- Clock Mounting Kit (see Section 1.5)
- Operation Manual
- Programming Cable Kit¹ (see Section 1.7)

1.2.2 Model 1095A/C with External Antenna

- Model 1095A/C Industrial GPS Clock
- Clock Mounting Kit (see Section 1.5)
- Operation Manual
- External GNSS Antenna
- 6 meters of RG-6 Antenna Cable
- Grounding Block (see Figure 3.2)
- Programming Cable Kit¹ (see Section 1.7)

1.3 Optional Accessories

- Option 01, External GNSS antenna (see Section 1.4.6)
- GNSS Antenna Mounting Bracket (see Section 3.2.5)
- GNSS Surge Arrester (see Section 7.2)
- Programming Cable Kit (AS0067200, consists of adapter AP0007700 and cable CA0023600)
- Optional small rubber seal for sealing cable port (see Section 2.3 and 6.4.4)

1.3.1 Initial Programming and Setup Notes

For initial programming, make use of the Programming Port seen in Figures 1.1 – 1.4, and the Programming Cable Kit discussed above. This port and the cable kit simplify connecting and programming any function on the Model 1095A/C. For additional information on programming the Model 1095A/C through this port, see Section 4.2.

¹MODULAR DB-9 TO RJ11 ADAPTER AND RJ11 CABLE 7', allows you to connect your computer serial port to the RJ11 connector inside the unit.

1.4 Component Identification

1.4.1 Model 1095A with Internal Antenna

The Model 1095A comes standard with an opaque cover² and four annunciator LEDs. LEDs indicate clock status as follows: (1) Status – Green, (2) Stabilized – Green, (3) Unlocked – Red, (4) Fault – Red. For a description of the Model 1095A display indications, see Section 4.1.1.

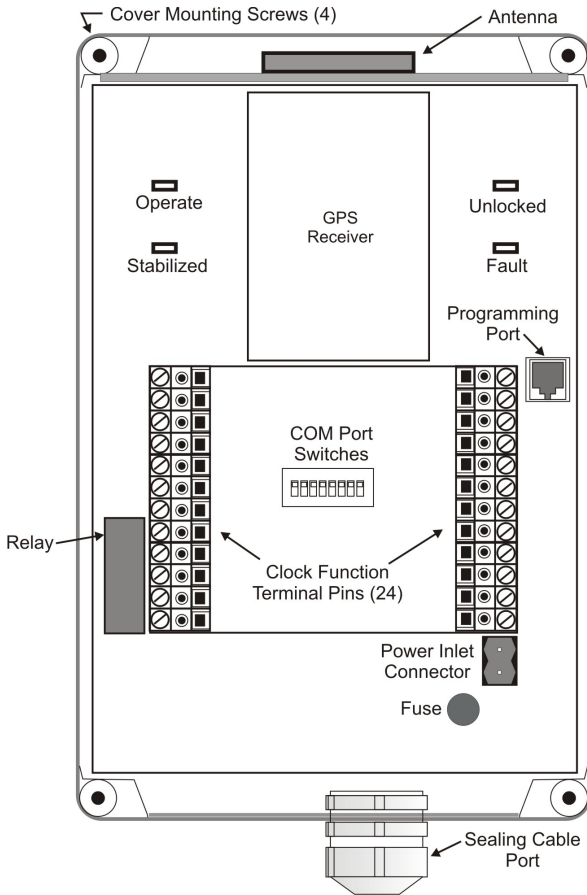

Figure 1.1: Model 1095A Front Panel, with Internal Antenna

²Model 1095A illustrated in Figure 1.1 shown without cover. A transparent, smoked cover may be ordered in place of opaque cover.

1.4.2 Model 1095C with Internal Antenna

The Model 1095C comes with a transparent, smoked cover³, six-digit time display and four annunciator LEDs that indicate clock status as follows: (1) Status – Green, (2) Stabilized – Green, (3) Unlocked – Red, (4) Fault – Red. For a description of the Model 1095C display indications, see Section 4.1.2.

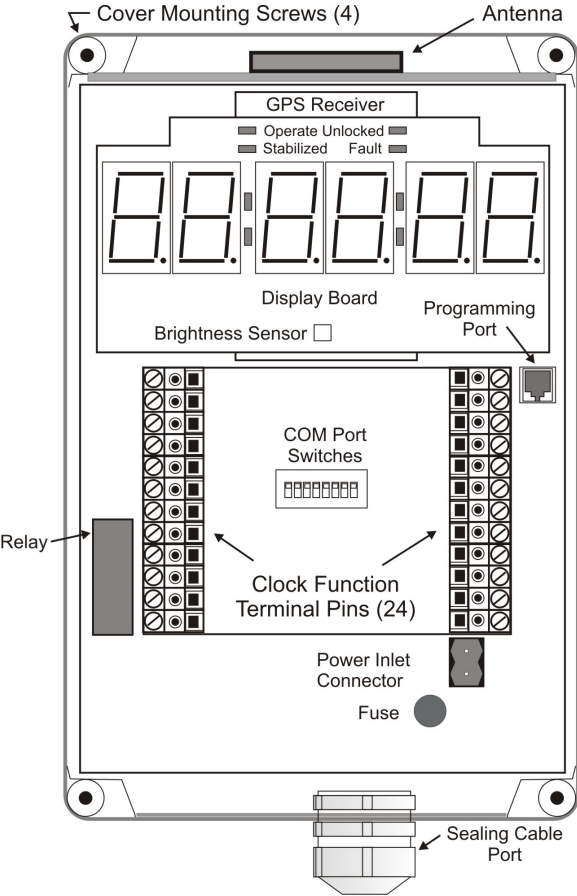

Figure 1.2: Model 1095C Front Panel, with Internal Antenna

³Model 1095C illustrated in Figure 1.2 shown without cover.

1.4.3 Model 1095A with External Antenna

The Model 1095A comes standard with an opaque cover⁴ and four annunciator LEDs. LEDs indicate clock status as follows: (1) Status – Green, (2) Stabilized – Green, (3) Unlocked – Red, (4) Fault – Red. Clocks with external antenna include a GNSS antenna, 6 meters of RG-6 antenna cable and grounding block. For a description of the Model 1095A display indications, see Section 4.1.1.

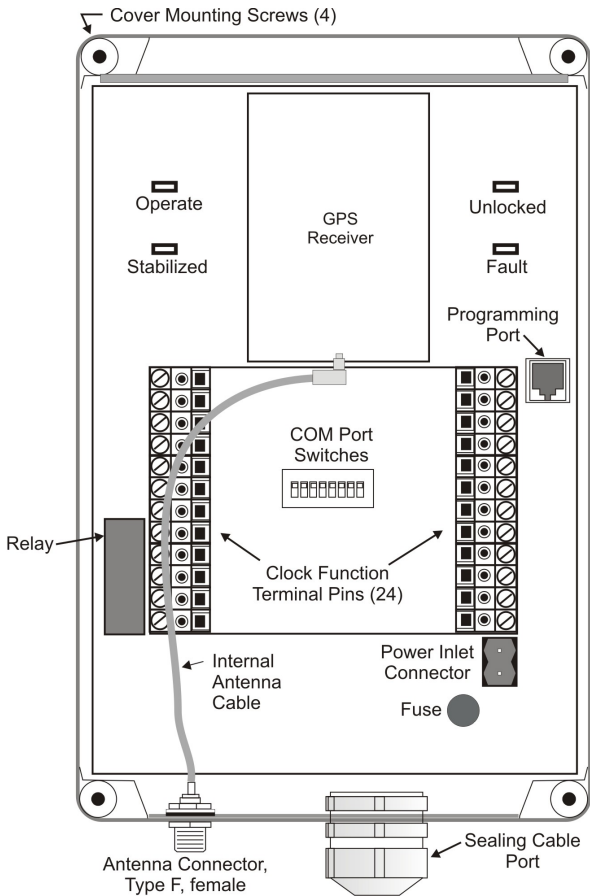

Figure 1.3: Model 1095A Front Panel, with Antenna Connector

⁴Model 1095A illustrated in Figure 1.3 shown without cover. A transparent, smoked cover may be ordered in place of opaque cover.

1.4.4 Model 1095C with External Antenna

The Model 1095C comes with a transparent, smoked cover⁵, a six-digit time display and four annunciator LEDs that indicate clock status as follows: (1) Status – Green, (2) Stabilized – Green, (3) Unlocked – Red, (4) Fault – Red. Clocks with external antenna include a GNSS antenna, 6 meters of RG-6 antenna cable and grounding block. For a description of the Model 1095C display indications, see Section 4.1.2.

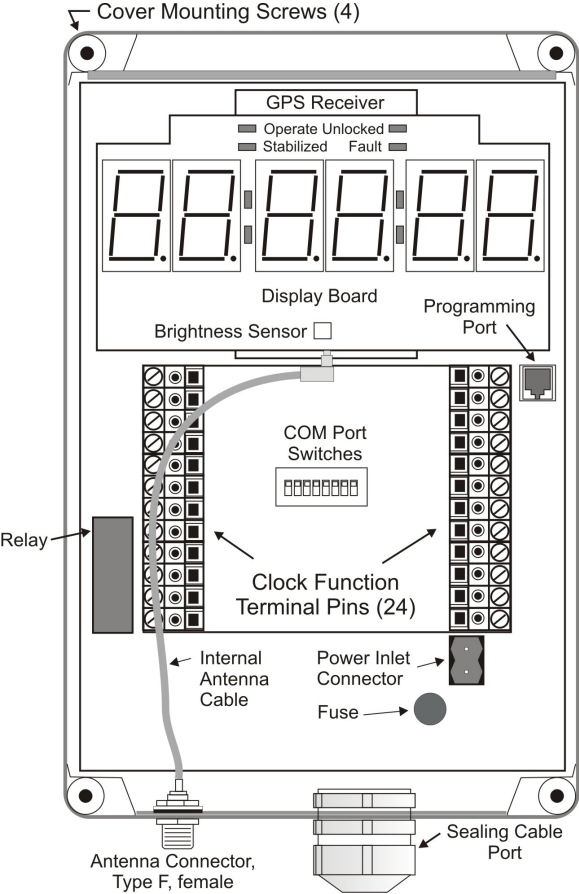

Figure 1.4: Model 1095C Front Panel, with Antenna Connector

⁵Model 1095C illustrated in Figure 1.4 shown without cover.

1.4.5 Clocks with Internal GPS Antenna

When mounting the Model 1095A/C outdoors, order it with an internally-mounted patch antenna, which is located at the top of the clock (see Figures 1.1 and 1.2. For proper GPS reception, the clock must be mounted with the top pointed up and a clear view of the sky in all directions of the compass. For instructions on mounting and GPS reception see Chapter 3.

1.4.6 Clocks with External GNSS Antenna

When planning to mount the Model 1095A/C indoors, order the Option 01, External GNSS Antenna. Option 01 adds a sealed female F-connector near the sealing cable port for attaching the external antenna cable and GNSS antenna. *An internal antenna is not installed.* If you purchased the Model 1095A/C with an external antenna, see Section 3.2 for additional information. Included in the kit are

- External GNSS Antenna
- 6-meter RG-6 antenna cable assembly
- Grounding block

1.4.7 Precautions

Note that the optional, external GNSS antenna is small and smooth, and can be damaged if dropped. Use care when handling. Remember to store the antenna in a safe place before the final installation to guard against mechanical shock.

1.5 Model 1095A/C Clock Mounting Kit

Figure 1.5 shows the Model 1095A/C mounting kit that comes with the Model 1095A/C. The kit includes four mounting tabs and the hardware to mount the clock. For mounting instructions, see Section 2.6.

1.6 Overview of Enclosure

Constructed of polycarbonate, the Model 1095A/C enclosure is designed to meet IP 66 and NEMA 4, 4X, 12 and 13 ratings, to be waterproof and protect it from all weather conditions. For clocks with an internal GPS antenna, the Sealing Cable Port provides access to all



Figure 1.5: Model 1095A/C Mounting Kit

electrical signals. Clocks with an external antenna include the Sealing Cable Port and a Type F connector. For additional specifications and technical details concerning the Model 1095A/C enclosure, please see Chapter 6.

1.7 Programming Cable Kit

The Programming Cable Kit (part no. AS0067200) consists of a seven-foot length of RJ11 cable and a DB9F to RJ11 adapter. This kit allows you to adapt directly from a serial port on a pc to the Programming Port (RJ-11 connector at J8), inside the Model 1095A/C. This port is switchable between the J1 terminals (TxD, RxD, GND) and the RJ11 connector using the DIP switch S1-8.

For computers equipped with a USB port and no DB-9 serial port, use a USB-to-serial adapter. Connect the programming cable kit adapter to the DB-9M connector on the USB-to-serial adapter to make the connection.

Chapter 2

Mounting and Wiring

This chapter covers wiring and mounting the Model 1095A/C Industrial GPS Clock. Designed to be mounted outdoors, the Model 1095A/C can be ordered with an internal GPS antenna. For indoor mounting, the Model 1095A/C may be ordered with the Option 01, external GNSS antenna (includes 6 meters of RG-6 antenna cable and grounding block), replacing the internal antenna.

2.1 Enclosure

The Model 1095A/C enclosure is designed for mounting indoors or outdoors. Enclosure design and construction materials, cover sealing gasket, sealing cable port, and optional antenna connector – assure weather proof operation. For enclosure dimensions, see Section 6.6.1.

2.2 Enclosure/Cover Seal

The enclosure cover is retained by self-captivating M4 stainless steel screws and integral stainless steel bushings (for repetitive assembly & disassembly). The cover gasket seals with two piece “tongue & groove” construction to provide protection against access of oil, dust and water. Gasket is factory poured using high temperature, U.L. listed, silicone rubber gasket material. When sealing the cover, tighten the four M4 screws to torque specifications found in Section 6.4.4.

2.3 Sealing Cable Port

To weather seal the cabling, the sealing cable port uses a rubber seal that can be ordered in two sizes: (1) 6 – 12 mm standard, and (2) 5 – 9 mm optional (order part no. AS0089800). These values represent the dimension of the outer diameter of the cable jacket usable with the specific seal size. Tightening the outer nut reduces the internal diameter of the rubber seal, securing the cable. For instructions on installing the cable and wiring, see Section 2.7.3.

2.4 Mounting the External GNSS Antenna

Connect the optional external GNSS antenna cable to Type F connector located next to the sealing cable port (see Figures 1.4.3 and 1.4.4). With an internal GPS antenna, a weather seal covers the optional antenna port.

2.5 Display

Model 1095A/C has four annunciator LEDs that display the following information:

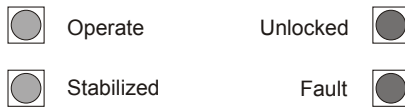

The Model 1095C also provides a six-digit, 7-segment time display with red, 20-mm (0.78-in) high characters. Covering the standard annunciator LEDs, the numeric display in the Model 1095C has a second set of annunciator LED's on the display board for better viewing. The Model 1095C also provides optional automatic dimming.

2.6 Installing the Mounting Tabs

Each Model 1095A/C comes with four mounting tabs suitable for mounting on most surfaces. These four mounting tabs attach to the rear panel of the clock using included hardware, and may be oriented on the rear of the enclosure in two ways. *Mounting tab kits include instructions.*

1. Drop the hex nut into the opening next to the cover-mounting screw and hold in place with a pencil or dowel.
2. Align the tab with the hole, in the desired orientation, and mount the M3 screw through the tab and into the rear panel mounting hole as shown in Figure 2.1.
3. Tighten the four screws.

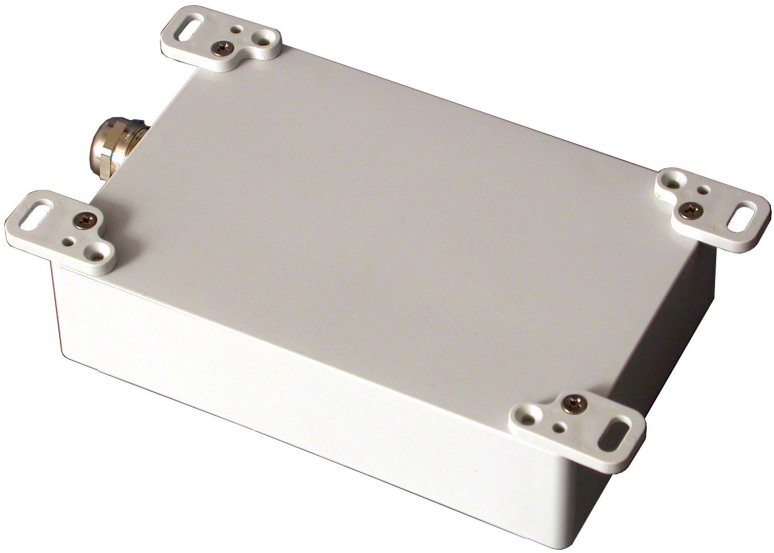

Figure 2.1: Model 1095A/C Mounting Tabs, Attached

2.7 Connecting Input & Output Wiring

This section will assist you with connecting all input and output signals to the Model 1095A/C clocks. All standard input and output signals are routed through the sealing cable port at the bottom of the clock housing; this includes inlet power.

2.7.1 Internal Antenna Operation

No antenna wiring is required when equipped with an internal GPS antenna. For GPS reception using the internal antenna, the Model

1095A/C must be mounted with a clear view of the sky in all directions of the compass. See Chapter 3 for more details on antenna mounting and GPS reception.

2.7.2 Optional External Antenna

Connect one end of the antenna cable to the Type F connector at the bottom of the clock housing. See Section 3.2.1 for more details on antenna mounting and reception.

2.7.3 Installing Main Wiring

This section will guide you through the installation of the cabling through the sealing cable port to the connector block terminals.

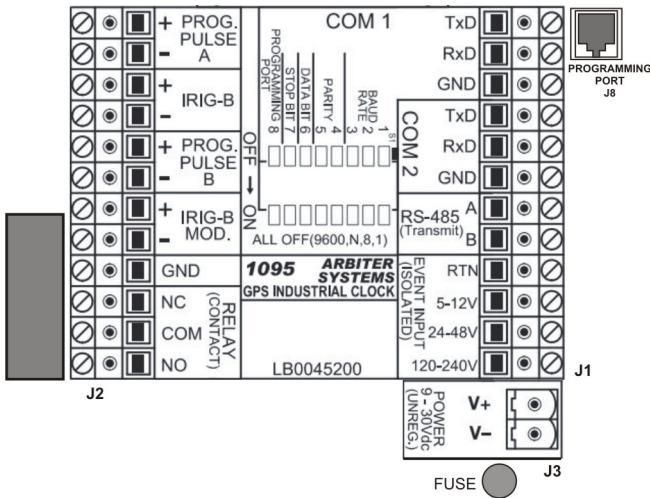

Figure 2.2: Connector Block Wiring

1. Remove the retaining nut, washer and rubber seal from the sealing cable port housing, inserting them over the cable.
2. Strip back the cable jacket covering with enough wire length to reach all of the intended connections at the terminals.
3. Strip each of the wires; DO NOT tin with solder.

4. Carefully insert the cable, with nut, washer and seal into the bottom of the sealing cable port housing and tighten the retaining nut until the cable is secure. To protect cable from slipping, provide external strain relief at mounting point.
5. Connect the chosen wire pairs to the Connector Block and verify. See Figure 2.2.
6. See Section 6.4.3 for additional mechanical information on wiring to the terminal blocks.
7. See Section 2.7.4 for definitions of terminal connections and DIP switch settings.

2.7.4 Signal Connections and Controls

Listed below are the meanings of the various connections on the connector block, and configuration methods. Use this section, including Figure 2.2, to identify and connect your chosen signal wires.

- **RS-232, COM1:** Connect to terminals, TxD, RxD and GND or RJ11 Programming Port. Configurable only with dip switches; positions are indicated in Table 2.1.
- **RS-232, COM2:** Connect to terminals, TxD, RxD and GND. Configure using the 1095 Utility Application (see Section 4.2).
- **RS-485 (Transmit only):** Connection to RS485-A and RS485-B only (half duplex).
- **Event Input:** Three input ranges: 5 – 12 Vdc, 24 – 48 Vdc, 120 – 240 Vdc, and RTN. Inputs are isolated. See Figure 2.2.
- **Inlet Power:** Two terminals, marked "+" and "-". Accepts 9 – 30 Vdc unregulated – reverse polarity protection.
- **Prog. Pulse A:** Two terminals, marked "+" and "-". TTL/CMOS level shift output (0 – 5V).
- **Prog. Pulse B:** Two terminals, marked "+" and "-". TTL/CMOS level shift output (0 – 5V).
- **IRIG-B:** Two terminals, marked "+" and "-". TTL/CMOS level shift output (0 – 5V).
- **IRIG-B MOD.:** Two terminals, marked "+" and "-". 1 kHz sinewave at 4.5 Vpp, 3:1 AM modulation ratio. See Figure 2.2.

- **GND:** Ground terminal (1 ea.).
- **Relay Contacts:** Three terminals, marked NC, COM and NO (Normally Closed, Common, Normally Open). Conditions are when relay is de-energized (clock powered OFF). The information below gives the contact condition for two states: (1) Fault, or Power OFF, and (2) No Fault, or Power ON.
 1. Fault, or Power Off – COM to NC shorted, COM to NO open.
 2. No Fault and Power ON – COM to NC open, COM to NO shorted.
- **DIP Switch Settings:** use the S1 DIP switches to configure COM1, RS-232 port parameters. This port cannot be configured through the serial port like COM2. Table 2.1 covers the settings for each switch (e.g. "Sw1"). * Default Settings.

Baud Rate	Sw1	Sw2	Sw3	Parity	Sw4	Sw5
1200	ON	OFF	ON	ODD	ON	OFF
2400	ON	ON	OFF	EVEN	OFF	ON
4800	ON	ON	ON	NONE*	OFF	OFF
9600*	OFF	OFF	OFF	–	–	–
19200	OFF	OFF	ON	–	–	–
38400	OFF	ON	OFF	–	–	–
57600	OFF	ON	ON	–	–	–
115200	ON	OFF	OFF	–	–	–

Data Bits	Sw6	Stop Bits	Sw7
7	ON	1*	OFF
8*	OFF	2	ON

COM1 Connector Select	Sw8
Terminal Lug Header*	OFF
Programming Port, RJ11	ON

Table 2.1: COM1 Dip Switches (*Factory default)

Ground Connection

Connect the GND terminal on the left terminal block (see Figure 2.2) to one or more wires of the multi-conductor cabling that are connected to a station ground.

2.7.5 Fuse

A user replaceable fuse pushes into the circuit board-mounted holder. Fuse by Little Fuse #370-1160, 250 V, 1.6 Amps. See Figure 2.2.

2.7.6 Inlet Power

Caution: Verify polarity before connecting inlet power connections. While the Model 1095A/C is protected from reversed polarity of the inlet power, it will not operate if reversed. Note that the negative inlet lead is nearest the fuse. See Figure 2.2.

2.7.7 Verifying Communication

To verify communications, or to configure, use the Programming Port at J8 (RJ11 connector). See Figure 2.2 at the upper right. An accessory, Programming Cable Kit (part no. AS0067200), includes an RJ11 serial cable and DB9F to RJ11 adapter. To make a serial connection between a computer and the 1095A/C, see Section 1.3.

1095 Utility Application

To communicate through the Programming Port (J8), *you must have Sw8 in the ON position.* In the OFF position, COM1 is connected through the terminal block (J1): TxD, RxD, GND. Verify all the other communication port settings so that they match those of the 1095 Utility Application. Baud rates are from 1200 to 115200; see Table 2.1. Default port settings are 9600 baud, 8 data bits, 1 stop bit, and NO parity. For more information on the 1095 Utility Application, see Section 4.2.

Using a Terminal Program

Alternatively, you may communicate with the Model 1095A/C using Windows HyperTerminal or other terminal emulation program such as Tera Term Pro¹. Follow the instructions and commands provided in Chapter 8. For more information on using HyperTerminal or Tera Term Pro, please see Section 4.3.1 or 4.3.2.

¹Tera Term Pro is a freeware download at <http://hp.vector.co.jp/authors/VA002416/teraterm.html>, or on the Arbiter website at the following link: <http://www.arbiter.com/software/downloads.php>, under "Miscellaneous"

Chapter 3

GPS Reception

This chapter covers topics associated with clock location, mounting, and GPS reception. For additional technical information on external antennas and cables, and using a surge arrester, see Chapter 7.

Reliable operation requires that the Model 1095A/C with internal antenna, or external antenna, be placed so that it continuously receives GPS signals for accurate time keeping. Clock installations without a full view of the sky may cause lapses in GPS reception with possible loss of synchronization (lock). If the clock should lose lock for any reason, information in this chapter should help in system recovery.

The Model 1095A/C achieves its accuracy by comparing the internal clock signal to the incoming GPS signals. Since the 24 active GPS satellites are constantly moving across the sky in their orbits, they move into and out of position for reception. Besides providing time to the Model 1095A/C, a composite signal from each satellite also gives information regarding the health of the satellite, so that the GPS receiver can decide whether to use it for timing purposes.

3.1 Basic Setup

For complete coverage, the Model 1095A/C needs to have a clear view of the sky from 10 degrees above the horizon to directly overhead for all points of the compass. Minimal installations, where the antenna is mounted in a less favorable location, may work however reception may be somewhat limited during certain hours of the day.

3.1.1 Antenna Operation

The internal GPS antenna receives 5 Vdc and approximately 30 mA from the clock, and provides about 35 dB of gain in a RHCP (Right Hand Circular Polarization) omnidirectional pattern over the antenna. Therefore, it is essential that the Model 1095A/C, or external antenna, be mounted with the top side pointed up for proper reception of GPS signals. See Figure 3.1.

3.1.2 Mounting Locations

Since the Model 1095A/C is designed to operate outdoors, it needs to be mounted so that the top of the clock is pointed straight up at the sky. See Figures 1.1 and 1.2 for antenna location inside the clock. Figure 3.1 illustrates the Model 1095A/C mounted above a structure with a clear view of the sky in all points of the compass.

Pole Mounting

While a pole may obscure satellites in the direction of the pole, normally there are enough satellites in view to compensate for the few (if any) that are blocked. Even those that are blocked will eventually move into view, as others may move out of view. Under most circumstances, a pole will not block enough satellites for the Model 1095A/C to lose synchronization. Note that once the Model 1095A/C is locked with a good geographical position, it should stay synchronized with only one satellite in view.

Panel Mounting

Use the included mounting tabs to mount the clock to a flat surface or inside a panel. See the information on the included mounting tabs in Section 2.6.

GPS Satellite Orbits, Positions and Reception

GPS satellites orbit the earth with a speed of 3.9 km per second and have a circulation time of 12 hours sidereal time, corresponding to 11 hours 58 minutes earth time. This means that the same satellite reaches a certain position about 4 minutes earlier each day. There are six orbital planes at an inclination of about 55 degrees above the equator, and rotated by 60 degrees around the equatorial plane. With four satellites in each orbital plane, there are a total of 24 active satellites with several

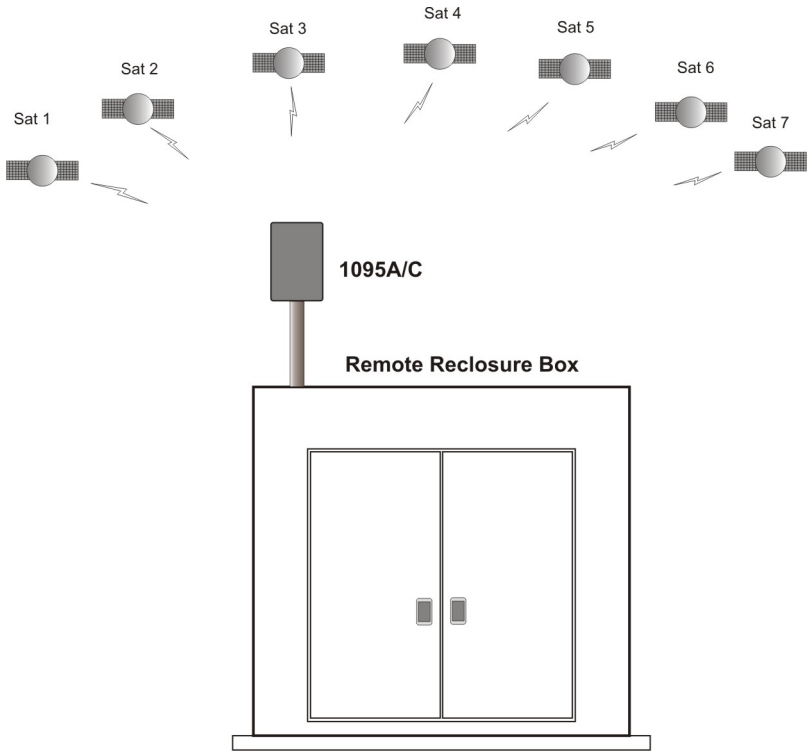

Figure 3.1: Model 1095A/C Mounting Situation

in reserve. This arrangement guarantees that there will be at least four satellites over any part of the earth at all times. Due to this arrangement, GPS receivers must be able to identify and track these satellites as they move across the sky, and decide which satellites are the most desirable to use for positioning and timing data.

Note that Figure 3.1 depicts GPS satellites in a two dimensional frame, and as such is inaccurate. A true representation of GPS satellite positions would be three dimensional, and would have satellites scattered all over the sky, moving in different directions.

3.2 Using an External Antenna

When planning to mount the Model 1095A/C indoors, order the Option 01, External GNSS Antenna. With this option, the Model 1095A/C will be equipped with a Type-F antenna connector next to the sealing cable port. Mount the external antenna with a clear view of the sky at all points of the compass. Partial views impose the same limitations as reviewed in Section 3.1.2 with the internal antenna.

3.2.1 External GNSS Antenna, Option 01

If you purchase the Option 01, External GNSS Antenna, with the Model 1095A/C it will include three components.

- GNSS Antenna
- RG-6 antenna cable assembly (6 meters)
- Grounding block, includes 2 male F connectors

Figure 3.2: Grounding Block



3.2.2 Using the Grounding Block

Bolt the grounding block to an earth ground, or ground using a short length of 8 – 14 AWG wire between the grounding block and earth ground. Connect the antenna cable between the GNSS antenna and the grounding block. Also included with the Grounding Block Kit are two RG-6 connectors for splicing in the grounding block. Alternately, fabricate an RG-6 cable to connect between the grounding block and the Model 1095A/C with external antenna connector. Use a suitable crimp tool to mount the connectors to the cable – cable, connectors and crimp tool are available from the factory.

3.2.3 Technical Details on External Antennas

Chapter 7 covers more information on using an external antenna with the Model 1095A/C. This includes (1) length and loss considerations,

(2) effects of cable parameters on the GPS signal, (3) cable delay, (4) attenuation, (5) DC resistance, (6) physical protection, (7) adjacent signal interference, and (8) surge arresters.

3.2.4 Mounting an External Antenna

1. Slide the pipe nipple over the antenna cable.
2. Attach the antenna cable to the antenna connector. **WARNING! Do not spin the antenna onto cable. Hand tighten the cable nut to compress the “O” ring.**
3. Thread the PVC pipe into the antenna.
4. Mount the plastic pipe and antenna/cable assembly to a fixture.

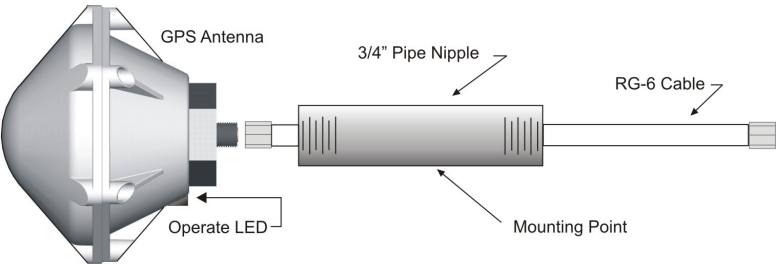

Figure 3.3: Antenna Assembly for Mounting

3.2.5 Optional Antenna Mounting Kit

The Antenna Mounting Kit (P/N AS0044600 - see Figure 3.5) includes several items including the mounting bracket (see Figure 3.4). The hardware included with the bracket allows installation of the antenna on a mast or pipe up to about 2" in diameter, and a different clamp may be substituted for use with a larger diameter pipe. Also, the bracket can be mounted to a wall, a roof, or any other flat surface. For complete details on this product, request document number PD0024700. All metallic hardware is made from stainless steel.

Qty	Description	ASI P/N
1	Mounting bracket, stainless steel	HD0052700
1	U-bolt, 1-1/8 in, SS, mounting plate, 2 hex nuts	HP0026700
1	Threaded pipe, 3/4 in x 4 in PVC, schedule 80	HP0014804
1	Hose clamp, 5/8 in x 1-1/4 in to 2-5/8 in, worm drive, stainless steel	HP0014900

Table 3.1: Antenna Mounting Kit, Parts List

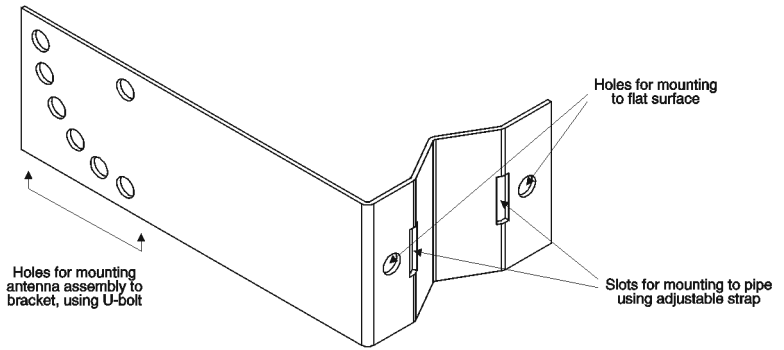

Figure 3.4: Antenna Mounting Bracket

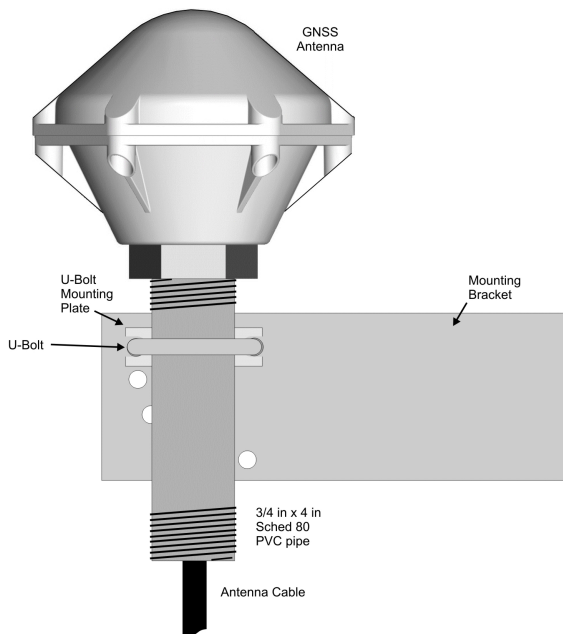

Figure 3.5: Antenna Mounting with AS0044600 Kit

Chapter 4

Startup & Configuring

4.1 Startup

NOTE: Apply only inlet voltages from 9 to 30 Vdc. *The Model 1095A/C is protected from reversed polarity of the inlet voltage, however if reversed the clock will not operate.*

The Model 1095A/C may be configured without being synchronized to the GPS. However, the Unlocked and Fault LEDs will be lit and time will not appear correctly on the Model 1095C. See page 25 for Model 1095C startup details.

1. Be sure to verify the inlet voltage level and polarity before connecting power. Verify connection by referring to Figure 2.2.
2. **Clocks with Internal Antenna:** Position the clock so that it can receive GPS signals. Sometimes being positioned against a window will allow reception of GPS signals for synchronization. For best GPS reception, follow the guidelines in Chapter 3.

Clocks with External Antenna: For clocks using external GNSS antennas, make sure that the antenna cable is connected to the Type F connector at the base of the clock and position the antenna outside so it can receive GPS signals.

3. Compare startup characteristics with description on the following pages, which normally occurs when power is applied to the Model 1095A/C with normal GPS reception.

4.1.1 Model 1095A Startup

The green Operate LED and the red Unlocked LED should illuminate, when power is first applied to the Model 1095A. After a short time of tracking satellites, the Unlocked LED should go out. After a few minutes¹ of operation while being locked to the GPS, the green Stabilized LED should light up.

- These indications will only be visible with the opaque clock cover removed. With a transparent cover they are visible with the cover in place.
- Lock and stabilization times above depend greatly on satellite reception, and are under fairly ideal circumstances².

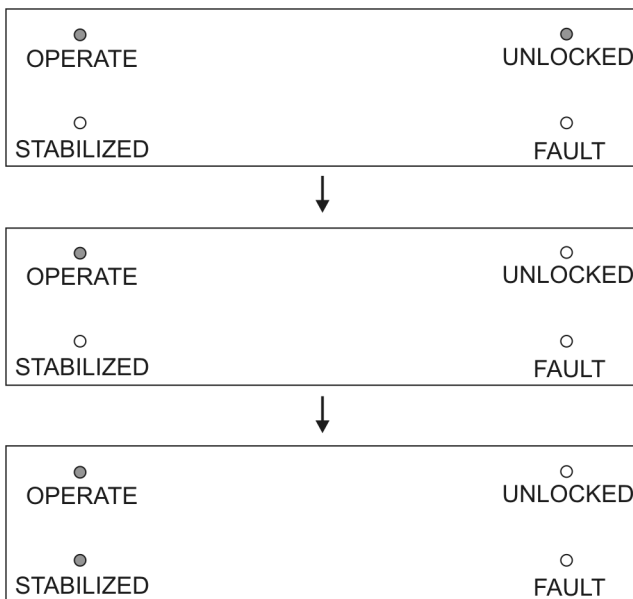

Figure 4.1: Model 1095A Startup Displays

¹It normally takes about four minutes to stabilize after achieving GPS lock.

²Clock, or antenna, should be mounted with a clear view of the sky from 10 degrees above the horizon to directly overhead for all points of the compass.

4.1.2 Model 1095C Startup

When inlet power is first applied to the Model 1095C, you should see the green Operate and the red Unlocked LED light up, and the large LED display should produce six dashes then zeros. After a short time of tracking satellites, the Unlocked LED should go out and the time display will begin counting. After a few minutes³ of operation, while being locked to the GPS, the green Stabilized LED should light up and the Model 1095C should display the correct time.

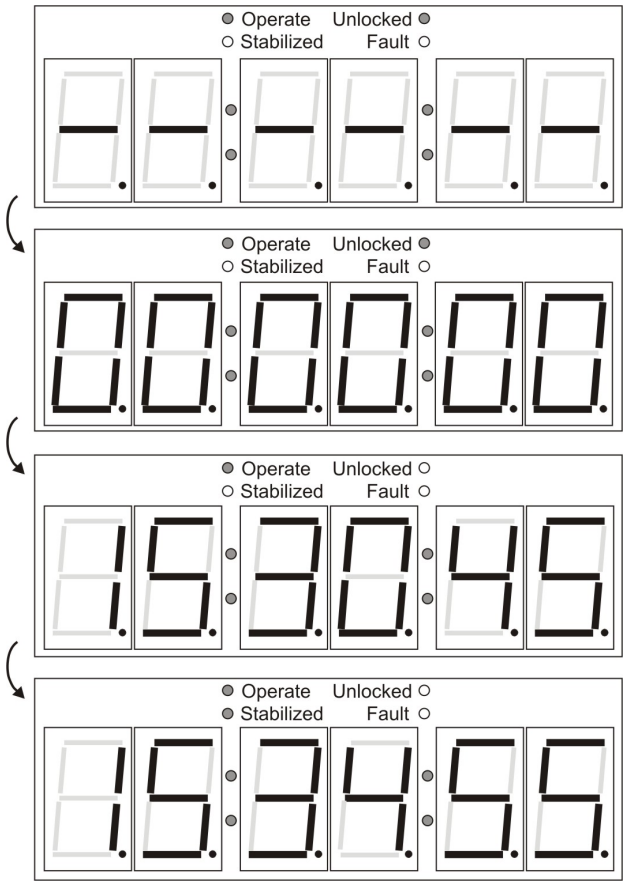

Figure 4.2: Model 1095C Startup Displays

³It normally takes about four minutes to stabilize after achieving GPS lock.

4.1.3 Model 1095A Fault Display

If the Model 1095A encounters a fault, the FAULT annunciator LED will light along with the Operate and possibly the Unlocked LED. Figure 4.3 below illustrates the clock display without antenna connected.



Figure 4.3: Model 1095A with Startup Fault

4.1.4 Model 1095C Fault Display

If the Model 1095C encounters a fault, the FAULT annunciator LED will light along with the Operate and possibly the Unlocked LED. Figure 4.4 below illustrates the clock display without antenna connected.

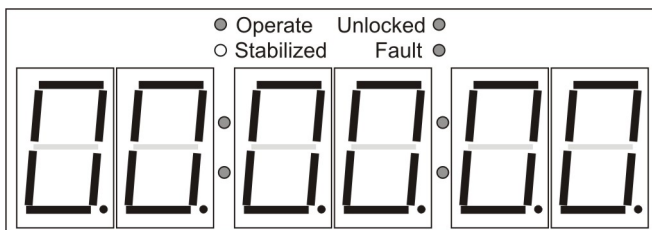

Figure 4.4: Model 1095C with Startup Fault

Fault Messages

The Model 1095A/C can supply, via either COM port, a fault message that identifies the fault. Possible fault messages are: (1) None, (2) Receiver (failure), (3) Antenna Short, (4) Antenna Open. To check for a specific fault, use the "FA" command; see Section 8.5.6. Shown below is a typical fault message using the "FA" command. This particular message is easily demonstrated by disconnecting the antenna.

Fault: Antenna Open >

4.2 1095 Utility Application

The following section illustrates how to use the 1095 Utility to configure the Model 1095A/C. It is compatible with Windows 2000, XP and Vista. Download the 1095 Utility from the Arbiter website at the following link.

<http://www.arbiter.com/catalog/clock/1095/1095ware.php>

The 1095 Utility allows you to read, write and verify operation on the Model 1095A/C. For pc's without serial ports, you will need to use a USB to serial converter.

The utility file is accessible from the Arbiter website and found under Downloads and the product "1095". Because the 1095 Utility runs on Python, it does not need to be installed. Double click the icon and the program should start as illustrated in Figure 4.5.

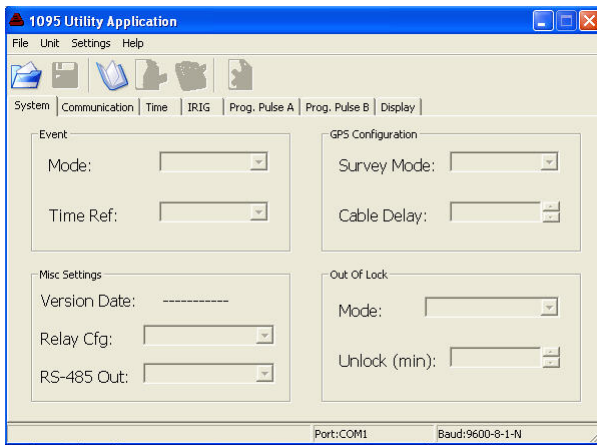

Figure 4.5: 1095 Utility Application, Opening Window

NOTE: It is not necessary to have the Model 1095A/C locked (synchronized to the GPS) to configure it using the 1095 Utility. Time and position data, however, will not be accurate.

Configure the Model 1095A and 1095C in the same manner. The most efficient method for configuring is through the use of the 1095 Utility. It is also possible to program the Model 1095A/C by sending basic commands through a terminal, or terminal emulation program. These commands are listed in Chapter 8.

4.2.1 Establishing a Serial Connection

Requirements for connection are as follows: (1) computer with serial or USB port (for USB, you will need a USB-to-serial converter), (2) a serial cable*, (3) 1095 Utility Application or terminal program.

***Using the COM1 Programming Port at J8**

Use the Programming Cable Kit, part no. AS0067200, to connect to the RJ11 Programming Port at J8. The kit includes a modular DB9F to RJ11 adapter and 7-foot cable. Make sure to set DIP switch SW8 to ON.

***Using the COM1 Port at J1**

To locate serial terminals, see terminal block J1 in Figure 2.2 and Table 2.1. Connect wiring to the three serial terminals, RxD, TxD, GND, per the table below. Make sure to set the DIP switch SW8 to OFF.

***Using the COM2 Port at J1**

Connect wiring according to the table below. DIP switches at SW8 do not affect COM2. Configure COM2 port parameters using COM1 and the Utility application.

PC, DB-9 Pins	–	1095A/C J1 Terminals
3, Tx	–	TxD
2, Rx	–	RxD
5, Gnd	–	GND

Connecting

1. Remove the cover and connect the desired cable depending on which connector you choose: COM1 at J1 or Programming Port at J8.
2. Power ON the Model 1095A/C, and start the 1095 Utility Application.
3. Select Settings > Serial Port > COM#, choosing the correct COM port associated with your computer; see Figure 4.6.
4. Select Settings > Serial Port > Baud Rate, choosing a rate to match that of the Model 1095A/C.
5. Select Unit > Read, or click the Read icon, and the 1095 Utility should connect and read all of the unit configuration.

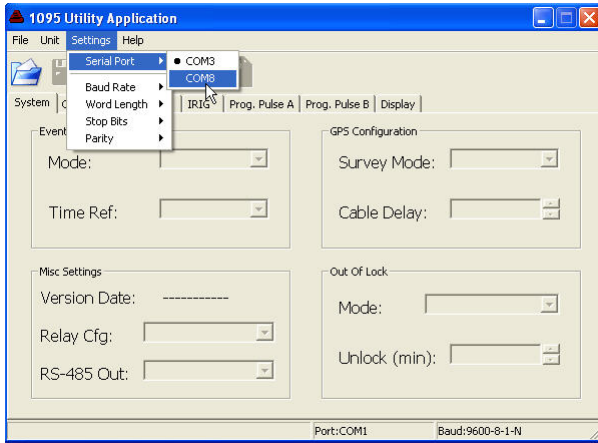

Figure 4.6: Connecting with the Model 1095A/C

Using USB-to-Serial Adapters

If for some reason the 1095 Utility does not connect properly with the Model 1095A/C then use the Windows Device Manager to verify which COM port Windows is using. If needed, reassign the COM Port to an unused number.

4.2.2 Reading Clock Configuration

When first starting the 1095 Utility there will be two functions open: Open and Read. Read allows you to poll the connected Model 1095A/C and download all of the configuration information. You can find "Read" by either by selecting Unit > Read, or by clicking the Read icon. When selecting the Read function by either method, the 1095 Utility will immediately try to read the connected clock. If it is successful, it will show a progress bar for a few seconds and then populate all of the values in the 1095 Utility windows. See Figure 4.7.

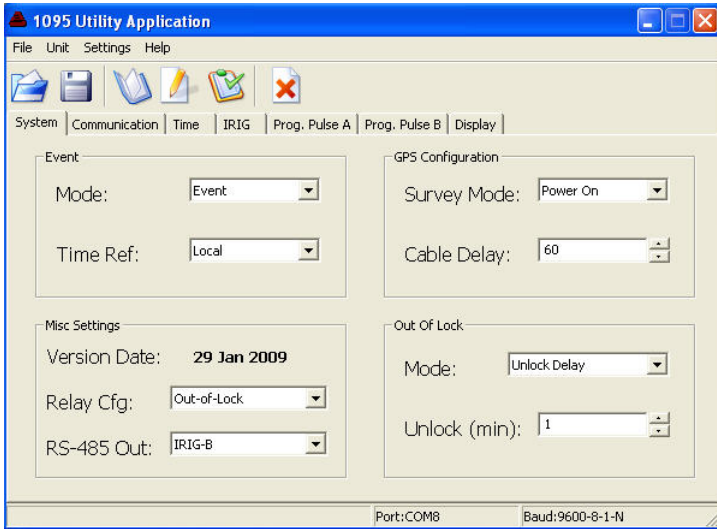

Figure 4.7: Reading the Configuration

If for some reason you get a message that the 1095 Utility could not read the clock, make sure to verify the following:

1. Configure the correct COM port on your pc (1095 Utility).
2. Configure the correct baud rate, or other settings (1095 Utility).
3. Connect the correct cable(s) between the Model 1095A/C and pc.
4. Set DIP switch SW8 to ON (see Table 2.1).

4.2.3 The System Screen

After selecting Unit > Read, or clicking the Read icon, the 1095 Utility will display the first tab information labeled "System".

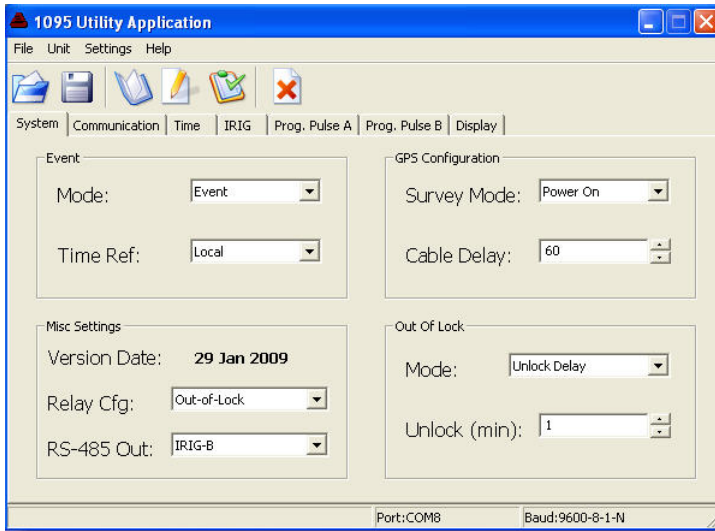

Figure 4.8: Reading the System Screen

DEFINITIONS

Event Mode: Choose "1PPS Dev." to set the 1PPS deviation mode; choose "Event" to set the event mode. "Time Ref." has two selections to set the Event time reference of the clock: either UTC or Local. To clear all events, see next page.

Misc. Settings: "Relay Cfg." selects the signal that drives the relay contacts; choices are Fault, Out-of-Lock, ProgPulseA, ProgPulseB, Stable and Event In. "RS-485 Out" selects the type of signal transmitted by the RS-485 driver, including: TXDCOM1, TXDCOM2, IRIG-B, Prog Pulse A, Prog Pulse B, 1PPS, Unlocked, and Event In.

GPS Configuration: Sets the "Survey Mode" to Power ON or OFF. Sets the "Cable Delay" to a number of nanoseconds dependent on the cable length; e.g. "24" (nanoseconds) for a 20-ft. cable length.

Out-of-Lock: Sets the out-of-lock "Mode" to Unlock OFF, Zero Delay or Unlock Delay. "Unlock Delay" sets the delay for the relay to actuate in minutes (from 1 to 99) when the clock is unlocked.

Clearing the Event Buffer

To clear all events stored in the event buffer, select Units > Clear Events, or click the "X" icon on the right (above the Prog Pulse A tab). See Figure 4.9. It is not possible to clear individual events.

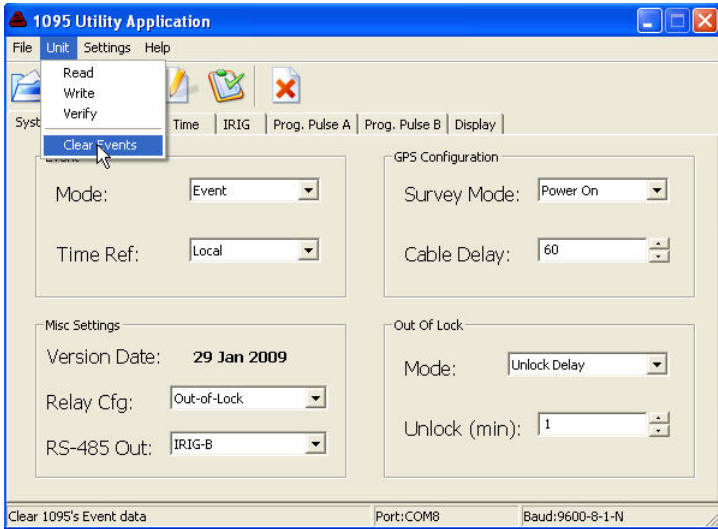

Figure 4.9: Clearing Events

4.2.4 The Communication Screen

Select the Communication tab to view and configure any communication parameters, including any broadcast mode – see Figure 4.10. While the 1095 Utility reads either COM1 or COM2, COM1 port settings are changed only through the dip switches inside the unit (see page 14). Configure COM2 port settings only through the 1095 Utility.

Broadcast Messages

Select from a list of broadcast messages, or a custom broadcast message, which may be created through the scripting as described in Section 8.2.1.

Broadcast Choices: Interrogate, ASCII Standard, Event Data, Vorne Standard, Status, Extended ASCII, ASCII plus Quality, Year plus ASCII, NMEA183GLL, NMEA183ZDA, ABB_SPA_MSG, Patek Philippe, and Kissimmee. For information on configuring a custom string, please see Section 8.2.3.

Broadcast String Structure: For details on each preconfigured broadcast string, please see Section 8.2.3.

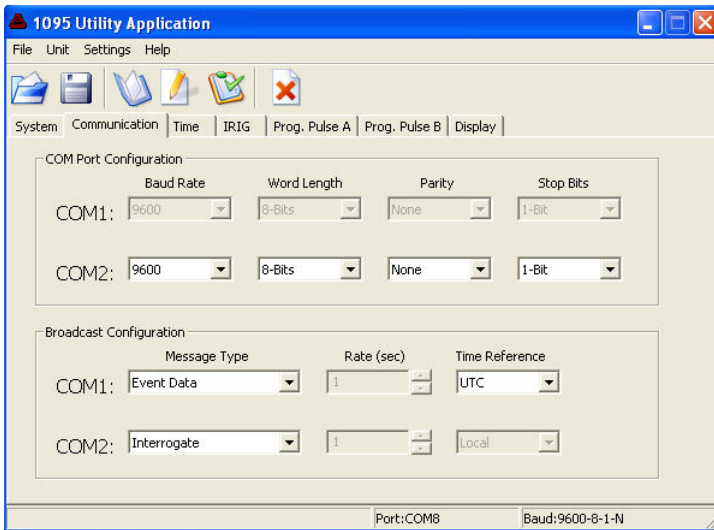

Figure 4.10: Communication Settings

4.2.5 The Time Screen

Select the Time tab to set up your Local Time Offset, which is the difference between UTC and your specific local time, excluding any Daylight Saving Time (DST) offset. DST adjusts your local offset and can be turned Off, On, or set to Auto for automatic changeovers in your specific locale. The default DST setting is for North America.

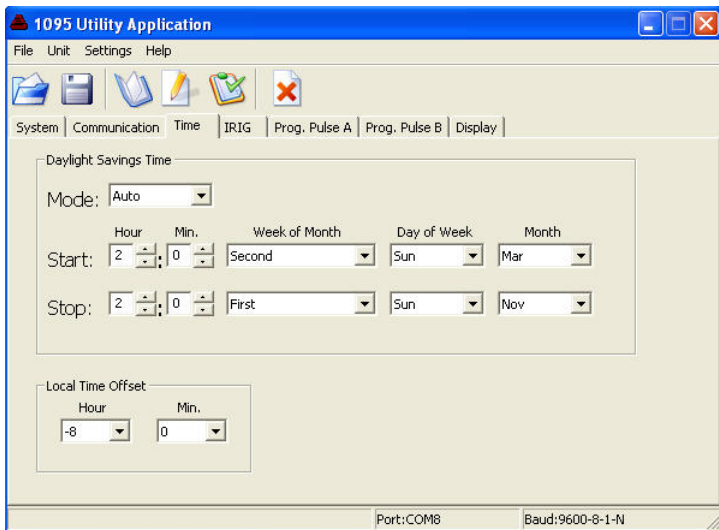

Figure 4.11: Time Adjustment Screen

Daylight Saving Time

In 2007 the U.S. Federal Government changed the start and stop dates to increase the number of days allotted to Daylight Saving Time (DST). Prior to the change, DST started at 2:00 a.m. the first Sunday of April and ended at 2:00 a.m. on the last Sunday of October. Currently, DST starts at 2:00 a.m. on the second Sunday of March and ends at 2:00 a.m. on the first Sunday of November. The result is an additional 4 – 5 weeks allotted to DST, depending on the specific year.

Since individual countries and regions have their own names, dates and times for a similar effect as DST, the Model 1095A/C is designed to adjust for all local times around the earth.

4.2.6 The IRIG-B Screen

Select the IRIG tab to set up how the Model 1095A/C transmits IRIG-B to your connected relays and IED's. Channel A refers to the two specific connectors labeled IRIG-B (unmodulated) and IRIG-B Mod (modulated). One mode of Prog. Pulse B allows you to configure unmodulated IRIG-B differently than for Channel A (see Section 4.2.8), providing a separate and independent instance of unmodulated IRIG-B.

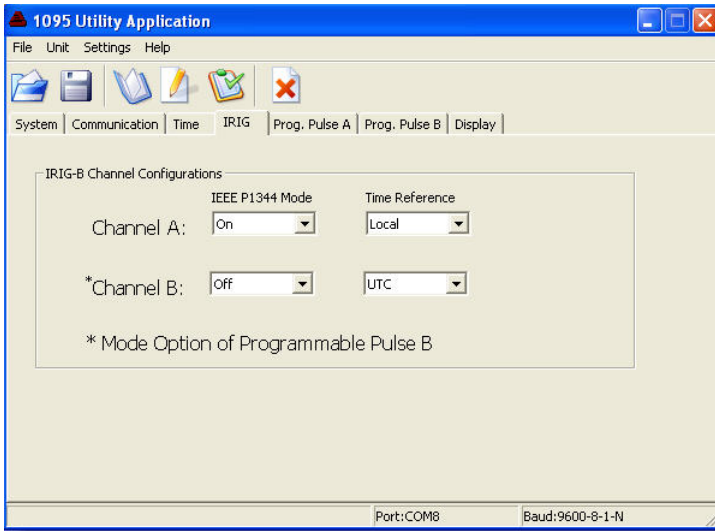

Figure 4.12: IRIG-B Adjustment Screen

IRIG-B Connection & Timing Information

For additional information on time codes, IRIG-B and connecting the Model 1095A/C to other equipment, please go to Chapter 5. Additionally, several application notes and white papers address connection issues in more depth, and are listed below. These may be obtained from the Arbiter website at <http://www.arbiter.com/>.

appnote101.pdf

irig_accuracy_and_connection_requirements.pdf

irig_b_spec_brief.pdf

4.2.7 The Programmable Pulse A Screen

Select the Prog. Pulse A tab to configure how the Model 1095A/C sends pulses to the Prog Pulse A terminals. Prog. Pulse A includes two modes and seven pulse types.

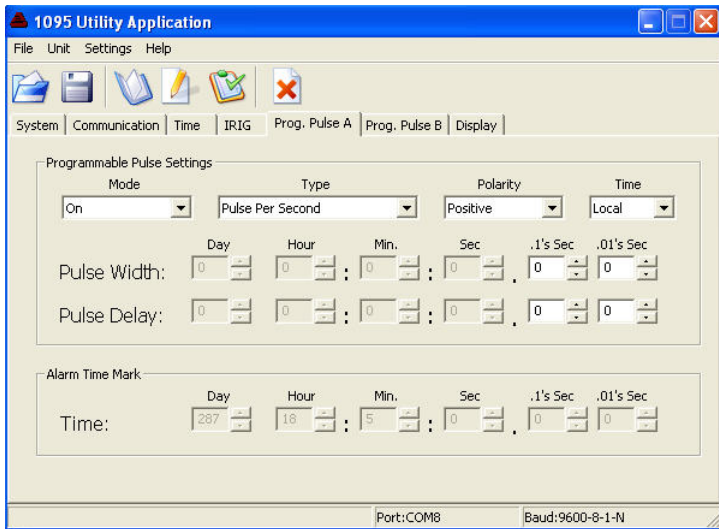

Figure 4.13: Programmable Pulse A Setup

DEFINITIONS

Modes: (1) On and Off.

Pulse Mode Types: (1) Pulse per Second, (2) Pulse per Minute, (3) Pulse per Hour, (4) Pulse per Day, (5) Single Trigger, (6) Slow Code, and (7) Seconds per Pulse.

Polarity: Pulses may be set to transition positively or negatively.

Alarm Time Mark: Specify the time and date, UTC or Local, for a pulse event.

Pulse Width: Specified in 10 millisecond increments up from 10 milliseconds (0.010 seconds) up to a full 24 hours depending on Mode.

Pulse Delay: Pulse Delay works in most modes, except in Alarm Time Mark and Slow Code. It delays the pulse by the selected value, after the top of the second, minute, hour or day depending on the chosen Pulse Type.

4.2.8 The Programmable Pulse B Screen

Select the Prog. Pulse B tab to configure how the Model 1095A/C sends pulses to the Prog Pulse B terminals; it includes four modes and seven pulse types. Prog. Pulse B is identical to Prog. Pulse A except that it includes two additional modes: (1) Frequency, and (2) IRIG-B.

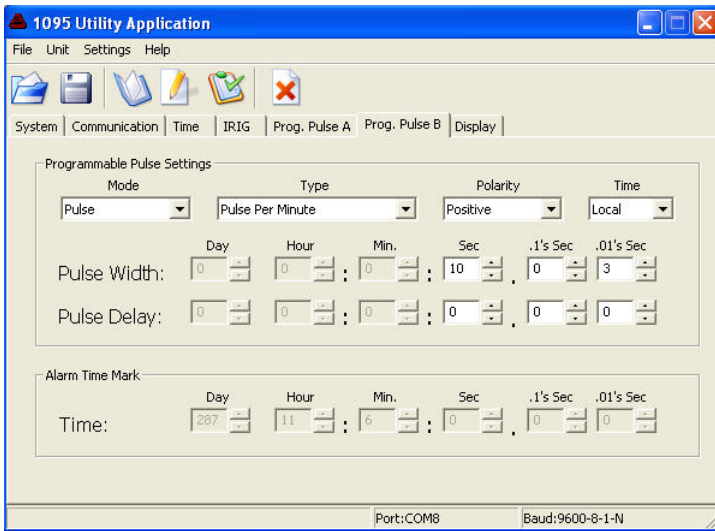

Figure 4.14: Programmable Pulse B Setup

Modes: (1) Off, (2) Pulse, (3) Frequency, and (4) IRIG-B.

Pulse Mode Types: (1) Pulse per Second, (2) Pulse per Minute, (3) Pulse per Hour, (4) Pulse per Day, (5) Single Trigger, (6) Slow Code, and (7) Seconds per Pulse.

Frequency: Set frequency, from 1 to 1000, in pulses per second; no other settings are available. Pulses have 50 percent duty cycle.

IRIG-B: Select "IRIG-B" as Mode and go to IRIG tab, Channel B, to set up IRIG-B preferences. IRIG-B from Channel B is independent from IRIG-B from Channel A.

Polarity, Alarm Time Mark, Pulse Width, and Pulse Delay: See definitions on Programmable Pulse A in Section 4.2.7.

4.2.9 The Display Screen

Choose the Display tab to control how the display operates *on the Model 1095C only; it has no control over the Model 1095A annunciator LEDs*. There are three controls: (1) Display Mode, (2) Time Reference, and (3) Brightness.

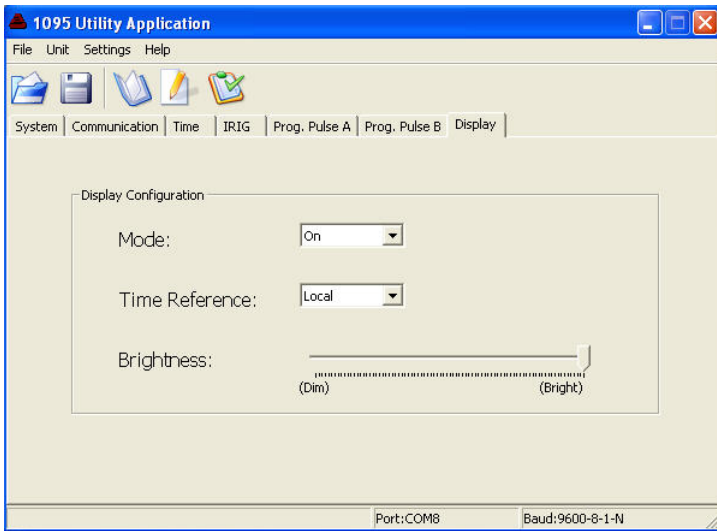

Figure 4.15: Display Control

Mode: There are three modes: ON, OFF, and AUTO. Selecting ON or OFF switches the display on and off. Selecting AUTO automatically adjusts the brightness based on the ambient light.

Time Reference: Select either UTC or Local so that the display will indicate either UTC time or your local time. Local time is determined by choosing the correct Local Time Offset for your locale and Daylight Saving adjustment (if applicable) in the Time screen (see Section 4.2.5).

Brightness: For manual brightness control, set the Mode to ON and adjust the slider to manually set the display brightness. Brightness may also be set using the "LE" command described on page 93. *Note that the brightness will not change until the new configuration is written.*

4.2.10 Saving a Configuration File

After going to the effort of configuring the Model 1095A/C, save it to a file for later use using the 1095 Utility.

To save a configuration file of the current clock setup, select File > Save, or click the Save icon in the 1095 Utility. When you do so, a Save Configuration window will appear for you to enter a file name and select a file location for the configuration file. The file will attach a ".1095" extension to the name.

4.2.11 Uploading a Configuration

To upload a configuration to a Model 1095A/C, you must first Read a Model 1095A/C, or have saved a configuration file (as described above).

1. Either Read a Model 1095A/C, or select File > Open (or click the Open folder icon) and choose the configuration file for uploading to the Model 1095A/C. The 1095 Utility will read the file and populate all of the configuration items in each tabbed display.
2. Select Unit > Write, or click the Write icon, and the progress window should indicate that the file is being written to the unit.
3. At the end, you can verify that the new configuration matches the file by selecting Unit > Verify or by clicking the Verify icon.

During the verification process, the program will compare all of the configurations in the Model 1095A/C with those of the file. A progress bar will indicate the comparison process. At the end, a window will appear and identify any items that did not match.

4. With no verification problems, the Model 1095A/C should be updated with the new configuration.

Programming Multiple Units

5. If you have multiple units to program, you should be able to connect the cable to the next unit and select Unit > Write, or click the Write icon.

When programming multiple units, make sure to verify baud rate and other port settings.

4.3 Using Terminal Emulation Programs

4.3.1 Using HyperTerminal

An alternate method of configuring the Model 1095A/C through COM1 and COM2 is to use a terminal, or terminal emulation program, like HyperTerminal. Also, certain functions (e.g. events) are only available through using a terminal or terminal emulation program.

Connecting with HyperTerminal

1. Start HyperTerminal, give your connection a name (e.g. 1095A) and select "Connect Using" and choose the correct COM port for your computer.
2. In the COM(#) Properties window, choose the same properties as you have set on the Model 1095A/C. Under "Flow Control" choose "None."

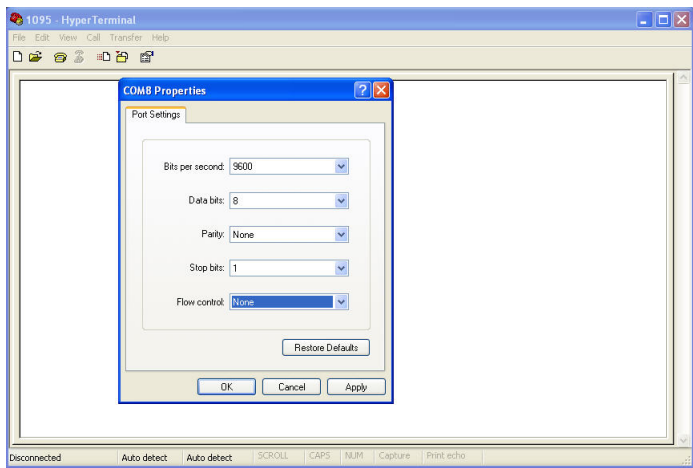

Figure 4.16: HyperTerminal Window, Port Settings

3. You should be looking at an open terminal window with a blinking cursor.
4. Type in the characters, "VE" and the Model 1095A/C should return the firmware version date code. For this example, the response came back as follows: 15 Nov 2013.

4.3.2 Using Tera Term Pro

Tera Term Pro is more useful than HyperTerminal because its features are easier to use and it allows you to change port parameters while the program is open. The program is freeware and you may download it from the Arbiter website shown below.

http://www.arbiter.com/misc_software/

Connecting with Tera Term Pro

1. Start Tera Term, select the Serial radio button and choose the correct COM port number for your computer.

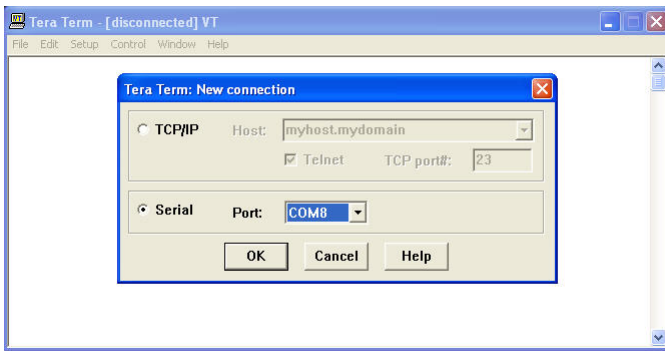

Figure 4.17: Tera Term Pro Window, COM Port Selection

2. Under Setup, check Serial Port and verify that the baud rate and other settings agree with your Model 1095A/C.
3. Type in the characters "VE" and the Model 1095A/C should return the firmware version date code. For this example, the response came back as follows: 15 Nov 2013.

Chapter 5

Timing Signals – IRIG-B and Event Triggering

5.1 Introduction

This section should help you with understanding, choosing and connecting the correct outputs from the Model 1095A/C series clocks to synchronize your external equipment, such as protective relays. It should also answer some basic questions, such as:

- What are the different types of IRIG-B?
- How do you connect multiple devices to one timing output?
- How far can you transmit timing signals?
- What type of cabling and connectors should I use?

The steps involved in synchronizing your devices to the GPS are fairly simple and should not take long to complete. To expedite the process, make sure that you know:

1. the type of timing signal each piece of equipment requires, and
2. how to enable the equipment to receive the timing signal.

Various methods are used to configure equipment to receive IRIG-B time codes including setting a physical jumper, or setup program. Some equipment can auto detect the timing signal, so that nothing else is required, other than connecting the cable.

5.2 Timing Output Description

When viewing the Model 1095A/C connectors, you will see that all input and output signals are routed through the sealing cable port as illustrated in Figures 1.1 and 1.2. Connections themselves are at J1, J2, J3 and J8 as illustrated in Figure 5.1 (same as Figure 2.2). Generally, there is a power inlet voltage, timing output signals and some communication path (e.g. RS-232). If you ordered an external antenna, there will be an optional type F connector mounted next to the sealing cable port.

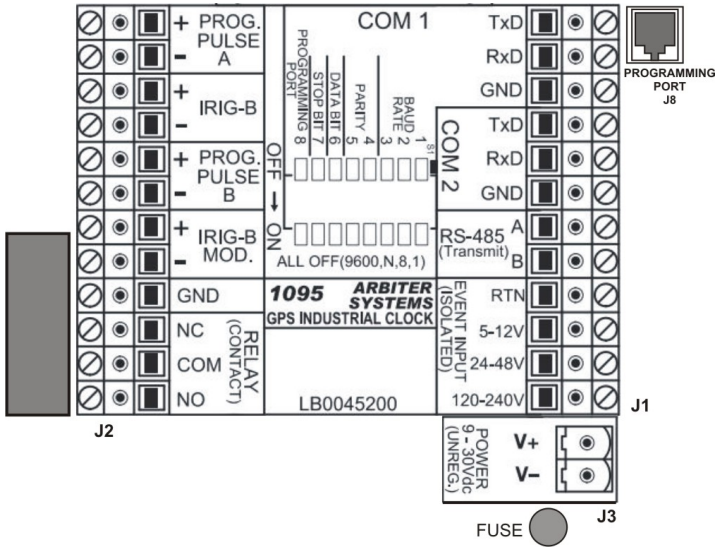

Figure 5.1: Connector Terminals

5.2.1 Standard Inputs and Outputs

Timing signals to external equipment originate from the J2 connector block terminals. Terminal block J2 provides one unmodulated IRIG-B, one modulated IRIG-B, two programmable pulse outputs (A & B), ground and a set of Form-C relay contacts.

5.2.2 Digital Drivers

The Model 1095A/C has three high-drive digital outputs capable of supplying 250 mA at greater than 4 Vdc. These outputs are defined as one (1) unmodulated IRIG-B, and two (2) programmable pulse, one (Channel B) which may be configured as a second unmodulated IRIG-B. Each output may be fanned out to a number of receiving devices, depending on the overall load of the receiving devices. To determine the maximum number of devices that the digital drivers can support, you will need to sum the individual load currents for each device connected to the Model 1095A/C. Greater loads tend to improve the voltage stability.

5.2.3 Analog Drivers

The Model 1095A/C has one analog driver available exclusively for *modulated IRIG-B signals*. The analog driver supplies a 4.5 Volt peak-to-peak signal through a 19.6-ohm source resistor to connected equipment. As the load current increases, the voltage drop increases across the clock source resistor reducing drive voltage. Make sure to match the modulated output to within the required voltage range of the receiving device. Table 5.1 shows how the actual drive voltage varies with increasing load current. For IED's with a restricted input range, match the available drive voltage to the IED through a dropping resistor of adequate power rating.

Drive Current, mA	Actual Drive Voltage, Vpp
0	4.5 (no load)
1	4.48
10	4.3
100	2.54

Table 5.1: Drive Current vs. Voltage

5.3 Output Signal Description

The Model 1095A/C provides one unmodulated IRIG-B, one modulated IRIG-B and two programmable pulse signals. Programmable Pulse A has two modes: ON and OFF. Programmable Pulse B adds two additional modes: Frequency and IRIG-B. Pulse mode is useful for timing individual pulses at specific intervals or at a specific time of day or year. Frequency mode provides from 1 to 1000 pulses per second (Prog. Pulse B), at a 50% duty cycle. Programmable Pulse B may also be used as a second unmodulated IRIG-B configured independently from the standard IRIG-B.

Programmable pulse modes are similar to 1 PPS only they have an adjustable period and pulse width. Modes include, pulse per second, pulse per minute, pulse per hour, pulse per day, single trigger (once per year), slow code and seconds per pulse.

5.3.1 IRIG-B Description

IRIG-B is a complete serial time code that occurs once per second and, depending on the configuration, contains the day of year, hours, minutes, seconds, year and other important information. The Model 1095A/C transmits Format B with four variations as seen in Table 5.2.

Code	Signal Type	Code Components
B000*	Pulse width code, No carrier	BCD _{TOY} , CF, SBS
B003**	Pulse width code, No carrier	BCD _{TOY} , SBS
B120*	Sine wave, modulated, 1 kHz	BCD _{TOY} , CF, SBS
B123**	Sine wave, modulated, 1 kHz	BCD _{TOY} , SBS
*IEEE 1344 ON,	**IEEE 1344 OFF	

Table 5.2: IRIG-B Time Code, Types Available

The IRIG-B time code consists of 100 bits produced every second, 74 bits of which contain various time, date, time changes and time quality information of the time signal. Consisting of logic ones, zeros and position identifier bits, the time code provides a reliable method of transmitting time to synchronize various equipment.

There are three functional groups of bits in the IRIG-B time code, in the following order: Binary Coded Decimal (BCD), Control Function (CF) and Straight Binary Seconds (SBS). The BCD group contains only time information including the seconds, minutes, hours and days, recycling yearly. The CF group contains other time-related information including year, time quality, leap year, pending leap seconds and parity. The

SBS consists of the total elapsed seconds, restarting daily. Position identifiers separate the various components of the IRIG-B time code.

5.3.2 Modulated and Unmodulated IRIG-B

Figure 5.2 illustrates the primary differences between modulated and unmodulated IRIG-B. You will notice that while modulated IRIG-B is distinctive because of the 1 kHz sinewave carrier, it is similar to unmodulated IRIG-B since the peak-to-peak values of the carrier follow the same form as the digital waveform, where the information is contained.

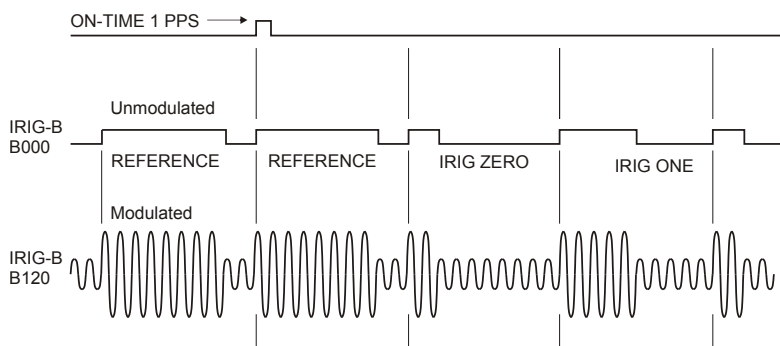

Figure 5.2: IRIG-B Waveforms

5.3.3 IRIG-B IEEE 1344 Extension

As mentioned above, the IEEE 1344 enables extra bits of the Control Function (CF) portion of the IRIG-B time code. Within this portion of the time code, bit assignments include:

- Calendar Year (old method, now called BCD_{YEAR})
- Leap seconds, and leap seconds pending
- Daylight Saving Time (DST), and DST pending
- Local time offset
- Time quality
- Parity
- Position identifiers

To be able to use these extra bits of information, protective relays, RTU's and other equipment receiving the time code must be able to decode them. Consult your equipment manual to determine if the IEEE 1344 feature should be turned ON in the clock. To view details of the IEEE Std 1344-1995, please check with the IEEE.

NOTE: To download a copy of the IRIG-B 2004 specification, please use the link to the Arbiter web site and look under Timing and Frequency, then Application Notes.

<http://www.arbiter.com/resources/documentation.php>

5.3.4 1 Pulse Per Second (1 PPS)

A one pulse-per-second timing output signal is very simple in concept. It is a digital bit transmitted every second with a pulse width of 10 milliseconds. Probably the most critical part of this signal is that the rising edge is "on time" as compared with the signal from the Global Positioning System (GPS). To produce a 1 PPS signal from the Model 1095A/C, use either Prog. Pulse A or Prog. Pulse B. See Figure 5.2 for a comparison between unmodulated IRIG-B and 1 PPS.

5.3.5 Programmable Pulse (Prog. Pulse)

Model 1095A/C series clocks have an independent programmable pulse feature that requires some firmware configuration through COM1 or COM2. Programmable pulse modes include setting the pulse mode, pulse width and time zone – see Table 5.3. To configure, please see Figures 2.2, 4.13 and 4.14.

Prog Pulse Mode	Configured Feature
Pulse Per Second	Fractional seconds after on-time mark
Pulse Per Minute	Number of seconds after each minute
Pulse Per Hour	Number of seconds after each hour
Pulse Per Day	Hour, Minute, Second, Fractional Seconds
Single Trigger	Day, Hour, Minute, Second, Fractional Seconds
Slow Code	ON or OFF
Seconds Per Pulse	X number of seconds between pulses
Pulse Polarity	positive– or negative–going pulse

Table 5.3: Programmable Pulse Modes

5.4 Connecting Outputs

Make timing signal connections through the sealing cable port and anchor using the terminal connectors on the left set of terminals (J2). To adapt to a BNC style connector, you may use a BNC Breakout¹, or other similar adapter.

5.4.1 Wiring to Screw Terminals

To connect timing signals, the Model 1095A/C series clocks have two rows of internal screw terminals (J1 and J2). To mount wiring to screw terminals, prepare the cable by stripping back at least 1/4" of the insulation and any shielding, and DO NOT tin the bare wire with solder. To attach wires to terminals, first loosen the screw counter-clockwise, insert the wire, then turn clockwise to tighten. Ground the shield (if present) to the GND (ground) connector on the clock board, rather than the receiving end. See also Section 2.7.3.

5.4.2 How Far Can I Run IRIG-B Cabling?

Before laying cable to transmit IRIG-B over long distances, take time to consider the following factors: (1) resistive losses in cabling, (2) electromagnetic interference, (3) propagation delays and (4) installation and maintenance costs.

For details on distributing IRIG-B signals over long distances, see application note, *AN101, Distributing Timing Signals in a High-EMI*

¹Pomona Electrics, www.pomonaelectronics.com, (800) 444-6785, (425) 446-6010, part no. 4969 and 4970

Environment. Download file *appnote101.pdf* at the following link (look under Timing and Frequency, Application Notes):

<http://www.arbiter.com/resources/documentation.php>.

For important considerations about IRIG-B connections, distribution of signals and accuracy, download the file at the same link, *irig_accuracy_and_connection_requirements.pdf*

5.4.3 Synchronizing Multiple IED's

In many installations, clock signals are "fanned out" to a number of devices from one clock timing output. This method makes more efficient use of the clock synchronizing capability since the clock drivers are designed to drive multiple loads. The exact number of possible loads must be determined from the input impedance of each connected IED.

5.4.4 Connecting Unmodulated IRIG-B

To drive multiple loads from one unmodulated IRIG-B output, make sure that the loads are wired in parallel. Sometimes this method is called "daisy-chaining", however the idea is to drive all loads in parallel from the single output. It is much simpler to connect loads to unmodulated IRIG-B than for modulated, because all of the loads should require the same voltage.

To determine load current for one Unmodulated IRIG-B output:

1. determine the number of loads to be connected to a single clock output
2. determine the impedance (or resistance) of each load
3. calculate the load current for each device ($I_{dev} = 5V \div R_{dev}$)
4. sum up all the load currents for the total current for one clock output; it must not exceed 250 mA.

Unmodulated Example

For example, if the input impedance of the IED is 5 kilohms, determine the device current (I) as seen in Calculation 5.1:

(5.1)

$$I = V \div R_{dev} = 5 \text{ Volts} \div 5000 \text{ Ohms} = 0.001 \text{ Amps (1 mA)}$$

If you were to connect ten of the same IED's to the same output, then the total current drawn would be $10 \times 0.001 \text{ A} = 0.01 \text{ A}$ (10 mA).

Another method is to determine the lumped impedance of all of the connected IED's in parallel. Then, determine the overall current by dividing the drive voltage (5 V) by the computed lumped impedance value. This current should not exceed 250 mA.

5.4.5 Connecting Modulated IRIG-B

The total load capacity for the modulated IRIG-B driver depends on the type and number of loads. The main difference in computing the load capacity for modulated IRIG-B and unmodulated IRIG-B is that many of the modulated IRIG-B decoders are fairly sensitive to the peak-to-peak voltage. With greater load capacity, the clock's modulated driver produces more current, which passes through the internal source resistor, dropping the available output voltage. The open circuit voltage (i.e. with no loads) is approximately 4.5 Vpp, so any connected loads will cause the available voltage to drop. It is a simple task to compute the available output voltage (Vpp) with a known current. See Calculation 5.2.

$$(5.2) \quad V_{pp} = 4.5 \text{ Vpp} - I \times 19.6 \text{ Ohms}(\text{source resistance})$$

Therefore, if you had 10 mA of load current (I load) the available voltage (Vpp) would be 4.304 Vpp. If the load current equals 100 mA, then the available voltage would be 2.54 Vpp. So, you can see how increasing the load current (i.e number of loads) affects the available drive voltage at the clock output. See also Table 5.1.

5.4.6 Wire Losses

Wire losses affect the available timing signal voltage applied to the device receiving the signal. Wire has a certain resistivity associated with it that is determined by its metallic composition, and its resistance determined by the diameter and length. For example, single-strand, 22 AWG (bare, enamel-coated) copper wire has a resistance of approximately 19.6 ohms per 1000 feet. To compute the loss we must include both wires in the connection, signal and return. For coaxial cabling, the resistance of the center conductor is rated differently than the shield. For a twisted pair, both of them should essentially have the same resistance per cut length. If we use a twisted pair of 22 AWG (copper as above), then the available voltage (at 100 mA of current) for 500 feet of wire including the source resistor is calculated in 5.3:

$$(5.3) \quad V_{pp} = 4.5 - I \times 19.6 \text{ source} - I \times 19.6 \text{ wire} = 0.58 \text{ Vpp}$$

So, you can see that most of the drive voltage is lost with 100 mA of current and 500 feet of 22 AWG twisted pair transmission line; this includes the voltage losses at the source resistor. 0.58 Vpp may very likely not be detected by the decoder in some IED's. *Remember to (1) make your cable runs as short as possible, (2) use a larger wire size, and (3) carefully distribute the loads.*

5.4.7 Voltage Matching for Modulated IRIG-B

With modulated IRIG-B, it was mentioned that certain decoders are very intolerant of drive voltage variation. If the IED specification says that the acceptable voltage range is 3.3 Vpp \pm 0.5 volt, and the available voltage is high, then you must reduce the voltage using a dropping resistor (R_{drop}). The value of the dropping resistor is determined by dividing the difference voltage (V_{diff}) by the device current (I_{dev}). For example, suppose that the available voltage is 4.5 Vpp (V_{oc}), the (nominal) acceptable voltage is 3.3 Vpp, and the device current is 10 mA. Determine the dropping resistor value.

First, you must determine the modulated output voltage at 10 mA of drive current. Next, you can calculate the value for the dropping resistor (R_{drop}) as seen in Calculations 5.4 and 5.5.

$$(5.4) \quad V_{out} = V_{oc} - R_{source} \times I_{dev} = (4.5 - 0.196) = 4.304 \text{ Volts}$$

$$(5.5) \quad R_{drop} = V_{diff} \div I_{dev} = (4.304 - 3.3) \div 0.01 = 100.4 \text{ Ohms}$$

The Power dissipation (P) is found from Calculation 5.6:

$$(5.6) \quad P = I^2 R = 0.01^2 \times 100.4 = 0.01 \text{ Watts}$$

In this example, an eighth-watt resistor should work fine.

For a voltage that is too low, the modulated IRIG-B signal level must be increased by some other means, such as (1) distributing the loads differently to reduce the current (raising the available voltage), (2) by reducing the cable loss by increasing the wire size, or (3) by distributing the loads differently.

5.4.8 Cable Delays

Compensate for antenna cable delays in the 1095A/C by using the 1095 Utility, or by using the "AD" command described in Section 8.11.1. To

set the cable delay using the 1095 Utility, see Cable Delay in GPS Configuration window under the System Tab in Section 4.2.3. However, the Model 1095A/C cannot compensate for the delay of output timing signals, therefore a delay in time must be expected due to the type and length of cable.

Electromagnetic waves travel at the speed of light (C) in free space or vacuum and a fraction of that speed through cabling. The speed of an electromagnetic wave in free space is given by Constant 5.7.

$$(5.7) \quad C \approx 9.84 \times 10^8 \text{ feet/second}$$

Since electromagnetic waves travel slower through any cable, cable manufacturers normally specify cable with a velocity factor (VF), which is a percentage of the speed of light in free space, and characteristic of the specific cable. The velocity factor for the RG-6 cabling used by Arbiter Systems for GNSS antenna connections, is about 83% of C. Most transmission lines have velocity factors in the range of 65% to 97%. Using these values you can determine the actual time delay in your cable distribution system and compare it to your required accuracy. As an example, 840 feet of RG-6 cable (with a velocity factor of 83%) would delay the timing signal by approximately one microsecond. For IRIG-B timing applications, these delays may not be important, compared to other criteria. Otherwise, you would be forced to compensate for the time delay using another method, such as advancing the timing output or placing another clock at the remote site.

5.5 Input Signal Timing

This section describes the two main features of input signal timing in the Model 1095A/C.

- event recording
- 1-PPS deviation measurement

These features are set up through the 1095 Utility (see Section 4.2.3), or by using a terminal or terminal emulation program. Recorded with 1-microsecond resolution, acceptable event signal levels are in three voltage ranges: 5 – 12 Vdc, 24 – 48 Vdc and 120 – 240 Vdc. Use a terminal emulation program and either COM1 or COM2 with specific commands to recall individual recorded events (see Section 8.3.3 and Section 8.4). The Model 1095A/C marks event data when viewed or retrieved using one of these two methods. Thus, if no event data points are viewed or retrieved, recording will be suspended

when the event buffer is full. As soon as event data is viewed or retrieved its address becomes available for recording.

5.5.1 Event Timing – Latency

Event data are recorded using a high-speed capture circuit operating with a 96 MHz time-base. Latency is limited by the interrupt processing speed of the clock's microcontroller, which in turn depends on its workload at the time the event is received. Since the workload varies from time to time, latency likewise varies. However, response time will, in general, never be less than a few hundred microseconds nor greater than 10 milliseconds.

5.5.2 Deviation Measurement

The event input can also be configured to display measured event times as 1 pulse-per-second (1 PPS) deviation measurements. This allows comparison of an external 1-PPS signal to the clock's precision internal 1-PPS signal. The clock determines the mean time difference between the two signals, which can be read via either COM1 or COM2.

5.5.3 Deviation Measurement Principle

The measurement technique employed for 1-PPS Deviation uses the same time determination and recording scheme used for Event Time measurement (see Section 5.5.2), but makes the assumption that the input signal is periodic and continuous. Also, the operation of the circular memory buffer is modified somewhat, in that recording does not stop after the first 300 events; new event data is given priority over existing data, and will overwrite it. Since the incoming signal is at 1 Hz and the circular buffer holds 300 events, each event time record will be overwritten once every 300 seconds.

Once every second the processor looks at the most recent group of 16 events. To compute deviation, it uses only the portion of the event data describing fractional seconds (e.g. values between 0.0000000 and 0.9999999). The 16 fractional-second values are normalized around 0.0000000, so that the range of results from the deviation computations will be centered on zero (± 0.5 seconds). It also computes the statistical Mean and Sigma (Standard Deviation) values on the 16 values. View these statistics via either COM1 or COM2 using event commands found in Section 8.4.

5.5.4 Connecting Input Signals

To receive input signals and to record events, you will need to connect your input signal to two of the four terminals depending on the voltage level; they are marked 5 – 12 Vdc, 24 – 48 Vdc, 120 – 240 Vdc and RTN. A 5-volt input signal would be connected between the 5–12V and RTN terminals. For input wiring connections, see Section 2.2.

5.5.5 Setting Event Channel Time

Set the event recording time to either UTC or Local through the 1095 Utility (see Section 4.2.3), or by using the nTA command from a terminal program. For example, "0TA" sets the event time to UTC, and "1TA" sets the event time to Local. For command reference, see Section 8.4.

5.5.6 Configuring for Event or Deviation Recording

Use the 1095 Utility to configure the Model 1095A/C for event or deviation recording (see Figure 4.8). Alternately, send commands through a terminal program, using the m,nEV command to configure the Event or Deviation function. For example, "0EV" configures the Event Mode, and "1EV" configures it to the Deviation Mode.

5.5.7 Accessing Data

Event data is *only* accessible through COM1 or COM2 using a terminal program and the serial commands, Broadcast Event, nED or EV. *Event or deviation data is not accessible through the 1095 Utility.* Use nED, with n = 1 to 300, to view a specific event by number. For example, type "29ED" to view event number 029. Use EV repeatedly to scroll up through the event buffer beginning at record 001. For example, type "EV", "EV" and you will see record 001 and 002. If you send "EV" later (as from the previous example), it will begin at record 003. Full details on these commands are located in Sections 8.3.3 and 8.4.

5.5.8 Broadcasting Event Data

For continuous viewing of event data, as they occur, set the clock to broadcast events, using either the 1095 Utility, or by using RS-232 commands. By broadcasting events as they occur, the Model 1095A/C will *continue to overwrite previous event data.*

5.5.9 Status of Event or Deviation

Use the SA command to determine the status of these functions. If you have configured the Model 1095A/C for event mode, send "SA" to return the read (R) and write (S) pointers. This tells you the current state of reading and writing in the event buffer. For example, typing "SA" returned the following response.

```
E R=004 S=026
```

This message tells you that (1) the Model 1095A/C is set for Event recording, (2) the current "read" pointer is at event record 004 (when using the EV command), and (3) that the "write" pointer indicates 26 records written to the event buffer.

5.5.10 Clearing Event Records

To clear the event buffer using the 1095 Utility, click the "X" icon or select Unit > Clear Events. Alternatively, use a terminal program connected to COM1 or COM2 (see below). "Clearing" means to completely remove all 300 records at one time. New events may be overwritten only if you view them sequentially, counting from Event 001. For information on clearing the event buffer, see Section 4.2.3 and 8.4.3.

Viewing individual event data marks them as available to be overwritten. For example, if you look at records 1 - 10, and events are occurring while viewing these records, they will be overwritten. Assuming the event buffer is full, and you are viewing data from records 15 - 20, events will not be overwritten until you also view records 1 - 14.

Clearing Events using a Terminal Emulation Program

Type or send "0,123EV" to immediately clear all events stored in the event buffer. See Section 8.4.3.

Chapter 6

Specifications

6.1 Introduction

The Model 1095A/C Industrial GPS Clock is designed to be installed either inside or outside. The Model 1095A has four annunciator LEDs for monitoring performance, and the Model 1095C has four annunciator LEDs and a large, six-digit time display. Interrogate and configure both models through RS-232 ports and included 1095 Utility software. For indoor mounting, both Model 1095A and 1095C may be ordered with an external GNSS antenna, cable and grounding block.

6.2 Receiver Characteristics

6.2.1 Timing Accuracy

Specifications apply at the 1 PPS and unmodulated IRIG-B outputs, with US Department of Defense Selective Availability (SA) OFF, as of date of publication.

UTC/USNO: ± 250 ns peak; $< \pm 100$ ns typical (SA off)

6.2.2 Position Accuracy

10 m, rms, 90 % confidence

6.2.3 Satellite Tracking

12 channel, C/A code (1575.42 MHz). Receiver simultaneously tracks up to twelve satellites.

6.2.4 Acquisition

Acquisition times may be longer with a restricted view of the sky.

- 150 seconds typical, cold start
- 15 minutes, 90% confidence, cold start
- 40 seconds, with almanac less than 1 month old
- 15 seconds, with ephemeris less than 4 hours old

6.3 I/O Configuration

6.3.1 Outputs

Three high-drive 5 Vdc (250 mA at > 4 V) and one analog, modulated IRIG-B (4.5 Vpp through 19.6 ohm source resistor); all terminal strip connectors.

- Output 1: Programmable Pulse A
- Output 2: IRIG-B00x level-shift
- Output 3: Programmable Pulse B
- Output 4: IRIG-B12x analog

6.3.2 Programmable Pulse Output

Two programmable pulse outputs, Prog. Pulse A and Prog. Pulse B are available at separate terminal connectors.

Modes

Most pulse modes (listed below) allow an adjustable pulse width and pulse delay. Pulse duration is programmable from 0.01 seconds to 24 hours in 10 millisecond increments, except in one-shot mode, where the output is TTL LO prior to the specified time and HI thereafter.

- Pulse per Second
- Pulse per Minute
- Pulse per Hour
- Pulse per Day

- Single Trigger (once per year)
- Seconds per Pulse
- 1 to 1000 PPS square wave (Prog. Pulse B only)
- Aux. IRIG Mode (Prog. Pulse B only)

6.3.3 Relay Contacts

One, Form C (SPDT) fail-safe, 5 A at 30 Vdc, 8 A at 250 Vac; jumper selectable to Fault, Unlocked, Prog. Pulse A, Prog. Pulse B, Stabilized and Event Input functions. Fail-safe means the relay indicates "fault" or "unlocked" condition with power off.

6.4 Interface

6.4.1 Operator

Display (1095C)	6-digit LED Time of Day.
Status LEDs (1095A/C)	Operate (green) Stabilized (green) Unlocked (red) Fault (red)
Setup (via remote interface)	Local time offset IRIG Setup: Local/UTC/1344 ON or OFF Daylight Saving Time: On/Off/Auto Event input: Event/1 PPS deviation Programmable Pulse setup Antenna Cable delay Out-of-lock time: 1 to 99 minutes(s), Off, or Zero delay Power-ON Survey, or OFF RS-232 Serial ports (2 ea.), called "COM1" & "COM2" COM1, DIP Switches COM2, RS-232 through 1095 Utility

6.4.2 System

RS-232	1200, 2400, 4800, 9600, 19,200, 38,400, 57,600, 115,200 baud; 7 or 8 data bits 1 or 2 stop bits; even/odd/no parity (COM1 configured via DIP switches) (TXD, RXD, COM) Broadcast modes include: ASCII, Extended ASCII, ASCII with Time Quality, and Vorne (output once
--------	--

every second), Status (output on change of Status) and Universal Configurable Serial Time Code

RS-422/485 Transmit only, to drive multiple devices; includes TxD-COM1, TxD-COM2, IRIG-B, Prog Pulse A, Prog Pulse B, 1 PPS, Unlocked, Event In

6.4.3 Suggestions for Main Wiring

The standard sealing cable port is suitable for mounting cable with an outer diameter ranging from 0.24 to 0.47 in (6 to 12 mm); choose alternate sealing port with dimensions 0.20 to 0.35 in (5 mm to 9 mm). Two Phoenix terminal blocks provide wire connections to the clock. This section gives additional information on the sealing cable port and the connector block.

Selected Connector Block Terminals Specifications

Screw thread	M 3
Tightening Torque	0.5 N m
Insulating Material Group	I
Rated surge voltage	4 kV (III/3, III/2, II/2)
Rated voltage	320 V (III/2), 640 V (II/2)
Connection STD	EN-VDE
Conductor, solid	0.14 mm to 2.5 mm (0.006 in to 0.098 in)
Conductor, stranded	0.14 mm to 1.5 mm (0.006 in to 0.059 in)

CSA

Nominal voltage, U	300 V
Nominal current, I	10 A
AWG/kcmil	28-14

CUL

Nominal voltage, U	300 V
Nominal current, I	10 A
AWG/kcmil	30-14

UL

Nominal voltage, U	300 V
Nominal current, I	10 A
AWG/kcmil	30-14
Certification	CB, CCA, CSA, CUL, GOST, SEV, UL

Terminal Connection Details

Turning the screw clockwise tightens, and counterclockwise loosens, the terminal connector screws. Screws are tightened completely clockwise when leaving the factory. *Before inserting wire, make sure to turn the necessary connector screws counterclockwise to fully open the connector jaw, then turn clockwise to tighten.*

6.4.4 Sealing Cable Port Specifications

Standard configuration includes a weather-resistant, sealing cable port for wiring all signals and power to and from the Model 1095A/C. Multi-conductor cable can be sized so that the sealing cable port will seal when tightened. One such cable that works is Belden 9747, audio, control and instrumentation cable. Belden 9747 has 12 pairs of 22 AWG stranded wire with PVC insulation and a PVC jacket. The nominal outer diameter is 0.425 inches.

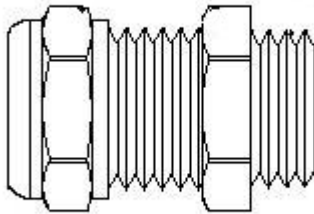

Figure 6.1: Sealing Cable Port

Selected Sealing Cable Port Specifications

Cable Range 1 (Standard)	6 mm to 12 mm (0.24 in to 0.47 in)
Cable Range 2 (Optional)	5 mm to 9 mm (0.20 in to 0.35 in)
Thread Size & Type	1/2 in NPT
Clearance Hole	20.3 mm (0.80 in)
Degree of Protection	IP65

Hummel part no.
Cover Screw Torque

1.609.1200.70
30 cN m 2.5 lbf-in

6.5 Power Requirements

6.5.1 Standard

Voltage 9 Vdc to 30 Vdc unregulated, 10 W max.
3.81 mm terminal strip, connector included

6.6 General

6.6.1 Physical

Size 120 mm × 180 mm × 60 mm
(4.7 in × 7.1 in × 2.4 in), without sealing cable port
120 mm × 200 mm × 60 mm
(4.7 in × 7.88 in × 2.4 in), with sealing cable port

Weight 1 kg (2.2 lb), net
2 kg (4.4 lb), shipping

Sealing Cable Port Accepts multi-conductor cable with an OD from
6 mm to 12 mm (0.236 in to 0.470 in)

Degree of Protection IP65 (IEC 60529)
NEMA 1, 2, 4, 4x, 12, 13

6.6.2 Environmental

Temperature	Operating	Storage
Instrument	-40 °C to 85 °C	-40 °C to 85 °C
Antenna (external)	-40 °C to 85 °C	-55 °C to 100 °C
Antenna Cable (external)	-40 °C to 75 °C	-40 °C to 80 °C
Humidity	10 % to 90 % non-condensing	10 % to 90 % non-condensing

Table 6.1: Temperature and Humidity List

6.6.3 Certification and Approvals

CE mark/label and certificate - see Appendix A and B.

Chapter 7

External Antenna, Technical Details

7.1 Antenna Cable

The standard antenna is designed for pole mounting on a 26-mm pole (1.05-in. OD or 3/4-in. ID pipe), with either a standard 1-in. – 14 (approximately M25.4 x 1.81) marine-mount thread or a 3/4-in. NPT pipe thread. The Type F connector on the inside of the antenna is protected from direct exposure to the elements when the antenna is mounted in this way. This will extend the operational life of the antenna-to-cable interface.

7.1.1 Length and Loss Considerations

When ordering an external antenna with the Model 1095A/C, you will also receive a 6-meter (20-foot) length of RG-6 type low-loss coaxial cable, terminated with male Type F connectors, and a grounding block. Optional lengths of RG-6 coax are separately available; see Table 7.1 (Cable Data and Accessory Information), or call the factory.

7.1.2 Effects of Cable Parameters

To receive GPS signals and properly synchronize the clock, the type and length of the cable are important. Due to their effect on specific parameters described in the following paragraphs, any changes to the

length and/or type of antenna cable should be made carefully. Damaged cables may also affect performance.

7.1.3 Cable Delay

The velocity factor and the physical length of the cable determine cable delay. During the initial factory calibration of the clock, a value for cable delay (based upon the length and type of cable supplied) is entered into the clock memory. Firmware uses this figure to counteract the effect that the delay has upon GPS timing. The value entered for a standard 6-meter cable is 24 nanoseconds. For other cable options, the delay is tabulated in Table 7.1. To calculate cable delay, see Equation 7.1:

$$(7.1) \quad T = \lambda \frac{1}{CKv} + 1ns$$

Where:

T = Cable delay, in nanoseconds;

λ = Cable length, in meters;

C = Speed of light (3×10^8 meters per second);

Kv = Nominal velocity of propagation (0.85).

One nanosecond is added to the calculated value to account for the length of the short connecting cable inside of the clock.

7.1.4 Attenuation

Attenuation depends upon the cable length, and the loss per unit length. The total attenuation must be limited to 21 dB (maximum) at the GPS L1 frequency of 1575.42 MHz. Loss up to 42 dB can be accommodated with the separately available 21-dB in-line preamplifier (P/N AS0044700).

7.1.5 DC Resistance

The cross-sectional area and length of the conductors in the cable determine the dc resistance. Since power to the RF preamplifier in the antenna is supplied via the antenna cable, excessive dc resistance will degrade performance.

7.1.6 Accessories for Longer Cable Runs

Arbiter Systems offers longer antenna cables for use with all models of clocks when the standard 6-meter (20-foot) cable is inadequate. For RG-6 cable runs greater than 250 feet, up to 500 feet, Arbiter offers a 21-dB in-line amplifier, P/N AS0044700. A larger RG-11 style cable is available (P/N WC0004900, 305-m / 1000-ft roll), that can be used for runs to 120 meters (400 feet) without the in-line preamplifier, or 240 meters (800 feet) with the AS0044700 amplifier.

P/N	Description	Delay, ns	Signal Level, dB
CA0021315	15-m (50-ft) cable, RG-6	60 ns	-5 dB
CA0021330	30-m (100-ft) cable, RG-6	119 ns	-9 dB
CA0021345	45-m (150-ft) cable, RG-6	177 ns	-13 dB
CA0021360	60-m (200-ft) cable, RG-6	236 ns	-17 dB
CA0021375	75-m (250-ft) cable, RG-6	295 ns	-21 dB
WC0004900	305-m (1000-ft) roll RG-11	3.92 ns/m	-17.5 dB/100 m
AS0044800	RG-11 Kit and crimp tool	N/A	N/A
AS0044700	21-dB in-line amplifier	1 ns	+21 dB

Table 7.1: GPS Cable Data and Accessory Information

7.1.7 Physical Protection

When routing the antenna cable, protect it from physical damage, which may result from closing doors, falling objects, foot traffic, etc. Also, when routing around corners, allow for sufficient bend radius to prevent kinks. Extra length should be allowed at both ends of the cable to prevent tension on the connectors, which could cause damage or failure. Extra length is useful as a service loop, in the event that a connector needs replacement.

Do not stretch the cable mid-air over any appreciable distance without support. Cable degradation or failure could result. Always leave a drip loop wherever the cable enters a structure, to prevent water from entering the structure via the cable jacket. The maximum temperature rating for the type of cable provided with the clock is 75°C (167°F). Exercise care when routing the cable near sources of heat to avoid cable damage.

7.1.8 Adjacent Signals

Although the standard RG-6 style cable is triple-shielded and has excellent shielding properties, be cautious when routing near high power RF sources or alongside cables carrying high power RF, such as transmitter cables. In these applications, consider using RG-11 style cable (P/N WC0004900). Its quad-shielded design provides even more isolation.

7.1.9 Antenna Power

The RF preamplifier within the antenna requires 5 Vdc at 30 mA nominal for operation, supplied by the clock through the antenna cable. Avoid shorting the center conductor to the shield of the coaxial cable as it may damage the preamplifier. Conversely, a high-resistance connection or open circuit would deprive the preamplifier of power. Either a short- or open-circuit condition in the antenna cable will render the clock inoperable.

7.1.10 Cable Connection to External Antenna

The male Type F connector on one end of the antenna cable mates with the female Type F connector on the antenna. Avoid placing mechanical stress on the cable attachment to the antenna.

7.1.11 Cable Connection to Clock

The male type-F connector on the opposite end of the antenna cable connects to the female type-F connector near the sealing cable port at the bottom of the clock. *Only clocks with provision for external antennas will have this antenna connector.*

7.1.12 User-Supplied Antenna Cables

Any RF cable meeting the requirements described above for loss (<21 dB at 1575 MHz) and dc resistance ($<15\ \Omega$ total loop resistance) may be used with the clock. However, prior to using a non-standard antenna cable, verify proper installation by performing the power supply test and antenna resistance test below.

7.1.13 External Antenna-Clock-Cable Testing

The Arbiter GNSS antenna has an Operate LED located at the base of the antenna. See Figure 3.3. It will glow Green if the voltage to the antenna is correct. It will glow Orange if the voltage is low. To check the antenna power, disconnect the antenna cable and measure at the antenna connector. With the clock powered ON, measure 4.9 to 5.1 Vdc between the center conductor and threads the of the antenna connector on the clock.

7.2 GNSS Surge Arrester Kit

The available GNSS Surge Arrester (P/N AS0094500) is compatible with the external antenna option, only. There is no external surge protection available for the Model 1095A/C with an internal antenna.



Figure 7.1: GNSS Surge Arrester

7.2.1 Description

The Model AS0094500 is a three-terminal device with two type F connectors and one ground terminal. The type F connectors are interchangeable. One connects to the antenna and the other connects to the receiver. A screw terminal provides a connection point for an earth ground wire. The arrester is weatherproof and may be mounted outdoors provided that the cabling and type F connectors are sealed from the weather.

7.2.2 Functions

1. Provides a solid and reliable grounding point.
2. Protects equipment from the damaging effects of electrical events.
3. Passes dc needed to energize the GNSS antenna.

7.2.3 Installation

Mounting Location

Location is a key consideration when installing the Model AS0094500. It should be mounted as close as possible to a good earth ground, such as a grounding rod or station ground grid. The shorter the path between the arrester and the earth ground, the more effectively it will bypass the induced voltages. Figure 7.2 illustrates the recommended mounting with the F-connectors facing downward. Install drip loops in the cables to reduce the likelihood of moisture penetration.

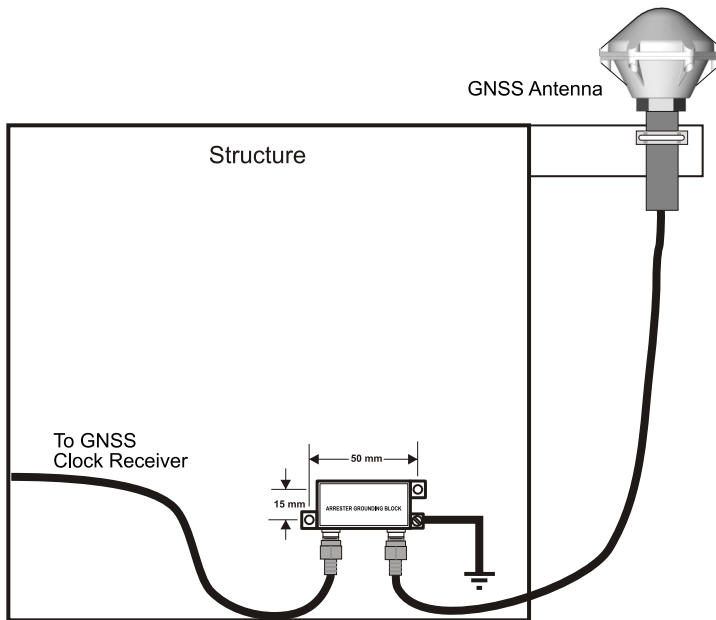

Figure 7.2: Suggested Mounting of the GNSS Surge Arrester

Antenna and Clock Connections

The type F connectors are interchangeable. One connects to the antenna and the other connects to the receiver. Use only a low-loss, tri-shield or quad-shield 75-ohm coaxial cable – RG-6 or RG-11 are the preferred cable types. RG-59, or other similar types of coaxial cable, should be avoided due to greater signal loss and poorer shielding at the GNSS frequency (1.575 GHz).

Ground Connection

Two methods are available for grounding the GNSS Surge arrester:

1. The ground-wire screw connection. Use the largest possible gauge wire and the shortest possible ground path. Hole diameter allows up to 8 AWG wire (0.129 in or 3.26 mm).
2. Hard-mounting directly to a grounded metal surface.

Weather Sealing the Connections

To protect from weather, use only type F connectors with appropriate sealing features. Typically this includes an o-ring in the male connector that seats against the face of the female connector on the surge arrester. Also, crimped connectors frequently include a silicone gel flooding compound, which enhances the ability of the connection to withstand the rain and humid conditions. To better seal the entire connection, cover the joint with GE Silicone II compound.

Use the proper crimping tool if using crimp-on connectors. Improper tools may not guarantee a strong and sufficiently grounded connector resulting in poor cable performance and GNSS reception. Consider purchasing RF cables of various standard and custom lengths manufactured by Arbiter Systems.

7.2.4 Physical Dimensions

Overall:	59 mm × 38 mm × 18 mm 2.32 in × 1.49 in × 0.71 in
Mounting Hole Dim:	50 mm × 15 mm (1.97 in × 0.591 in)
Mounting Hole Dia:	4 mm (0.157 in)
F Connector Dim:	24 mm, center to center
Weight:	48.2 g (1.7 oz)
Ground-wire terminal	Up to 8 AWG wire (0.129 in or 3.26 mm)

Chapter 8

Serial Command Reference

8.1 Introduction

The Model 1095A/C has two RS-232 ports and one RS-485 port, with a set of serial commands for configuring and controlling clock operation. While many users will choose to control clock operation with the 1095 Utility software (see Chapter 4), others may wish to develop their own interface program. Consult this appendix for information on how to communicate with and configure the Model 1095A/C without using the 1095 Utility.

COM1 settings are controlled mechanically by the 8-position dip switch in the center of the main board; settings are indicated in Table 2.1. COM2 settings are controlled by using the 1095 Utility Application or using COM Port Settings as described in Section 8.2.4. The COM1 and COM2 do not use flow control, and the RS-485 port functions in transmit only mode.

Use the two serial ports interchangeably for separate functions. You may wish to interrogate the clock on one port for basic information (i.e. to configure something) and at the same time be able to have the second serial port broadcasting a specific time code to a meter. Substation equipment commonly rely on IRIG-B time code, where others may receive ASCII data through the serial port. Another common serial-port function is to connect a digital wall display to indicate the time.

8.2 Serial Communication Definitions

This section is a complete command reference for Model 1095A/C serial ports. Where possible, RS-232 commands are functionally grouped into similar categories. For example, Section 8.9 lists all of the commands used to both set and retrieve the date and time in a standard format.

Each command name and syntax is highlighted in bold at the beginning of each definition. Detailed information for each command and response follows each command heading. Sometimes the command is very short, such as the command to return the Local Time: TL. Other commands require a prefix before the letter command to specify them, such as to start or stop a broadcast: m,n,o,pBR. For example, the command to start the ASCII Standard broadcast string at a rate of once per second, in Local time, from COM1 is 1,1,1,0BR.

When a command requests information from the Model 1095A/C, it returns the most current data available. Numeric data is returned as an ASCII string of numeric characters, with leading sign and embedded decimal point as needed. Strings are usually terminated with carriage return and line feed characters. Enter any RS-232C command as written in these tables *without* pressing ENTER. Characters are automatically entered when typed. If including any of these commands in a programming sequence, do not include any carriage-return or line-feed characters.

The following symbols and syntax are used throughout and are mentioned here for emphasis:

- ␣ = carriage-return, line-feed
- U = UTC Time
- L = Local Time
- soh = An ASCII character (start of header) = Hex 01
- bel = An ASCII character = Hex 07
- n = integer used for various numerical values (e.g. nnn in minutes)
- yyyy = four digit year
- ddd = Julian day-of-year
- mm = month
- hh = hour
- mm = minute
- ss = second

An underline is used for clarity only and graphically represents the location of ASCII spaces.

8.2.1 Broadcast String Overview

General Broadcast Command

Command: **m,n,o,pBR**

The BR command is used to start and stop the configured broadcast, and return broadcast string information as explained below. See Section 8.3 for information on starting and stopping the configured string at COM1 or COM2.

- m = m = 0 Stops Broadcast; m = 1 starts broadcast string;
m = 2 starts event broadcast.
- n = the update rate, from 0 to 9999 seconds
- o = the Time Zone, where 0 = UTC and 1 = Local
- p = the COM port, where 0 = COM1 and 1 = COM2

Some ...BR Command Examples

1,1,0,0BR – starts broadcasting the configured string at a rate of once per second, in UTC from COM1.

1,5,1,1BR – starts broadcasting the configured string at a rate of once every five seconds, in Local time from COM2.

0BR, 1BR – 0BR stops broadcast at COM1, 1BR stops broadcast from COM2.

2BR, 3BR – 2BR returns COM1 settings, 3BR returns COM2 settings.

Custom String Command

Command: **@@A ... , @@B ...**

Use @@A... to configure a custom broadcast string from COM1, and @@B... to configure a custom broadcast string from COM2. These two commands allow you to create a custom broadcast string from the characters found in Table 8.1, True/False and Ordinal Conditionals. In addition, see Section 8.2.2 for a selection custom string examples and tutorial on creating a custom string.

Character	Meaning
//	/ character
/Cssh	Xor checksum of specified range, where ss = start location (hex value from 00 to FF) and nn = number of bytes (hex value from 00 to FF)
D	Day of month (1, . . . , 31)
d	Day of year (001, . . . , 366)
e	GPS elevation (\pm dddddd.dd length = 10)
f	Fractional Seconds (00, . . . , 99)
/Hxx	Hexadecimal value where xx is a hex value from 00, . . . , FF
h	Hour (00, . . . , 23)
m	Minute (00, . . . , 59)
M	Month (1, . . . , 12)
O	Local hour offset (\pm hh where hh=0, . . . , 12)
o	Local minute offset (0, . . . , 59 minutes)
Pi	Latitude where i = 1, degrees (dd); = 2, Minutes (mm); = 3, Fractional minutes (mmmm); = 4, Seconds (ss); = 5, Fractional seconds (fff); = 6, N (North) or S (South)
pi	Longitude where i = 1, Degree (ddd); = 2, Minutes (mm); = 3, Fractional minutes (mmmm); = 4, Seconds (ss); = 5, Fractional seconds (fff); = 6, E (East) or W (West)
r	Carriage return and line feed
Sii	String Type where ii: 01 = Status change (receiver out of lock, antenna short, antenna open)
s	Seconds (00, . . . , 59)
Txx	On time character where xx is a hex value from 01 to FF (Note: Must be at the start or end of the string!)
U	Unlock time (00, . . . ,99 minutes)
W	Day of week (1, . . . , 7 where 1 = Sunday)
w	Day of week (1, . . . , 7 where 1 = Monday)
y	Year (00, . . . , 99)
Y	Year (2000, . . . , 2xxx)

Table 8.1: Characters used with Custom Strings

Table 8.1 Notes Conditionals can use any of the above, with the exception of /Cssnn and Txx, in addition to any string characters.

Conditionals cannot be nested!

True/False Condition – /{ii? < t > / :< f > /}

where: < t > = True condition < f > = False condition ii: 01 Out of Lock; 02 Status change; 03 Locked with max accuracy; 04 Fault; 05 Daylight Saving Time change pending

Ordinal Condition – /{ii? < 0 > / : , . . . , < n > / ; < e > }

where: < 0 > , < 1 > , . . . , < n > = ordinal position < e > = Else condition ii: 01 Time Quality (13 possible ordinals); 02 Time Zone Indicator (3 possible, 0=DST active, 1=Not active, 2=UTC)

8.2.2 String Setup Examples and Tutorial

The examples listed below illustrate how various strings are constructed using the @@A ... or @@B ... commands. This tutorial will build several strings already defined in the Model 1095A/C as examples to help you form a custom string of your own. In this way, you can form an existing string and compare the output with the standard method of activating that string (i.e. using the 1095 Utility as in Section 4.2.4). For example, to activate the ASCII Standard broadcast in UTC time zone at 1 broadcast per second from COM1, you would type 1,1,0,0BR.

Three elements are specified throughout the tutorial examples: (1) The desired output string is shown first, (2) Next, follows the input string code required to produce the output string, (3) Lastly, you will find some string construction notes to help you construct a valid input string from the table of characters shown in Table 8.1, true/false conditions and ordinal conditions.

ASCII Standard

Desired String: <soh>ddd:hh:mm:ss >

Input String Code: @@A/T01/d:/h:/m:/s/r

Input String Construction Notes: Note that the ordinary method of starting any serial broadcast is through the 1095 Utility (see Section 4.2.4). Custom string entry always begins with the @@A for strings output from COM1, or @@B for strings output from COM2. Next, the T01 specifies the on-time character as a Hex 01, which is the Start of Header. Notice

that these characters are preceded by the "/", which preceded each of the other (Table 8.1) characters. "d" is for Julian Day, "h" if for hours, "m" is for minutes, "s" is for seconds, and "r" is for carriage return, line feed. The ":" subdivides the Julian day, hour, minute and second, and no space between characters. After typing in the Input String Code (as shown above), press the Enter key. The code's acceptance is indicated by a carriage return line feed.

Vorne Standard

Desired String: 44hhmmss >
 55ddd >
 11nn >
 bel

Input String Code: 44/h/m/s/r55/d/r11/U/r/T07

Input String Construction Notes: Note that the ordinary method of starting the any serial broadcast is through the 1095 Utility (see Section 4.2.4). This input string code begins with the characters "44"; note that these are printed as that and are not preceded by a "/". "h", "m" and "s" follow and include a "r" for carriage-return, line-feed. "55" immediately follows the "r", then a "d" for Julian day, followed by another "r". "11" immediately follows the "r", followed by a "U" for unlock time and "r" for another carriage-return, line-feed. Lastly, the "T07" specifies the on time character as the Hex 07, which sounds the bel in the machine. Note that the "44", "55" and the "11" are not preceded by a "/" since they are printed as characters.

Status

Desired String: ddd:hh:mm:ss I=nn:nn X=nn:nn >

Input String Code: /[02?/d:/h:/m:/s /S01/r:/]

Input String Construction Notes: Note that the ordinary method of starting any broadcast is using the 1095 Utility (see Section 4.2.4). This string begins with a true/false conditional 02, which is a change of status. Since it is a part of the Table 8.1 character set, it must be preceded by the "/". After the "?", appears the Julian day, hours, minutes and seconds that indicate the day and time that the status changed. After the "s" (seconds) is an intentional space as shown in the input string code. After the space is the intended "/" and "S01", which indicates a status change string type of "01". The ":" separates

the "or" of the "true or false" conditions, only in this case there is no specified false condition.

Extended ASCII (DTSS MSG)

Desired String: >
 Q_yy_ddd_hh:mm:ss.000_

Input String Code: /T0D/H0A/[03? /: ?/] /y /d:/h:/m:/s.000

Input String Construction Notes: Note that the ordinary method of starting any broadcast is using the 1095 Utility (see Section 4.2.4). "T0D" sets the on time mark as a carriage return, and "H0A" is line feed. Immediately following is a "03", which is a "locked with maximum accuracy" conditional. This is followed by a space, which indicates that the clock is locked with maximum accuracy. If the condition is false, then it prints a "?". The "/" separates the true/false outputs. Outside the conditional statement are the normal values that are broadcast at the chosen rate. "y", "d", "h", "m" and "s" are the two-digit year, Julian day, hours, minutes, seconds, followed by three fractional second digits and three spaces.

ASCII + Quality

Desired String: <soh>ddd:hh:mm:ssQ >

Input String Code: /T01/d:/h:/m:/s/{01? /:./:*/:#/;/?}/r

Input String Constructions Notes: Note that the ordinary method of starting any broadcast is using the 1095 Utility (see Section 4.2.4). This string is very similar to the Standard ASCII described earlier appended with a quality indicator, "Q". All of the notes under ASCII Standard apply, except that "Q" is an ordinal. The ordinal will produce all of the necessary time quality values passed on by the clock. The ordinal begins with a "{" and ends with a "}". "01" is the selected (time quality) value governing the output character. Ordinals are a sequence conditional, meaning that you have values separated by a ":" (OR), and (in this case) at last is a ";" (ELSE). For ASCII + Qual, there are four OR conditions (specific time quality ranges) followed by one ELSE (worst quality range). The initial ordinal is a space, meaning maximum time quality followed by a ".", a "*", a "#" and finally by the ELSE condition of a "?". A carriage return line feed "r" ends the string.

ASCII + Year

Desired String: <soh>yyyy ddd:hh:mm:ssQ >

Input String Code: /T01/Y d:/h:/m:/s/{01? /:./:*/:#/;?/}/r

Input String Constructions Notes: Note that the ordinary method of starting any broadcast is using the 1095 Utility (see Section 4.2.4). The ASCII + Year is identical to the ASCII + Qual described above but includes the four-digit year followed by a space that preceded the Julian day. Notice that there are two characters for year: y (0 – 99) and Y (2000 – 2xxx).

Common ASCII Characters

Listed below are a few common ASCII control characters used with the Model 1095A/C. For a more complete listing of ASCII characters, you will need to consult a additional sources¹. Other printable characters may be typed in as seen on a keyboard.

Decimal	Hex	Abbreviation	Description
0	00	NUL	Null Character
1	01	SOH	Start of Header
7	07	BEL	Bell (sound)
10	0A	LF	Line Feed
13	0D	CR	Carriage Return

Table 8.2: Short Table of ASCII Characters

Preconfigured Broadcast Strings

Additional preconfigured strings are available from the 1095A/C by selecting them from the Communication tab in the 1095 Utility. Descriptions of all of the preconfigured strings are found in the following section (8.2.3). While they are not described in the preceding tutorial, you may download the Input String Code from each of them using the mCB command found on page 82.

Return Custom String – mCB

To return a custom string installed in the Model 1095A/C, use the mCB command, where m = 0 for Custom1 and m = 1 for Custom2.

¹ See Wikipedia, at <http://en.wikipedia.org/wiki/ASCII>

8.2.3 Preconfigured Broadcast Strings

Listed below are the syntax and meaning of the twelve preconfigured strings that may be installed into the Model 1095A/C. Use the 1095 Utility Application to install and start the desired string. Use the ...BR command, as described in this chapter to start and stop the broadcasts from a terminal program.

Interrogate Mode

In the interrogate mode the clock does not broadcast a message, but waits for a command.

Broadcast ASCII Standard

ASCII STD broadcasts the time of day as ASCII standard data from either COM1 or COM2 based on how it is configured in the 1095 Utility Communications panel, or from a terminal program.

Response: <soh>ddd:hh:mm:ss >

Broadcast Event Data

Configures to broadcast event data a new string for each new event. It will continue to broadcast events as long as it is configured to do so and new events are being recorded.

Response (Local) mm/dd/yyyy hh:mmP:ss.sssssss nnnAL >
(UTC) mm/dd/yyyy hh:mmP:ss.sssssss nnnAU >

Broadcast Vorne Standard

Configures to broadcast Vorne Standard data formatted for Vorne large format time displays from either COM1 or COM2. Refer to Arbiter Systems Application Note 103 for more information on using large format displays with GPS clocks from Arbiter Systems.

Response: 44hhmmss > (UTC/Local time)
55ddd > (day of year)
11nn > (out-of-lock time)
be1 > (be = Hex 07; sounds at the end of the time code)

Broadcast Status

Configures to broadcast specific clock information if the status changes.

Response: ddd:hh:mm:ss (Status Message) >

Status Messages include (1) RECEIVER (failure), (2) OUT OF LOCK, (3) LOCKED, (4) ANTENNA OPEN, (5) ANTENNA SHORT, and (6) ANTENNA OK.

Broadcast Extended ASCII

Configures to broadcast the time of day as ASCII using an extended format prefaced with a time quality indicator (Q). The start bit of the carriage return is transmitted on time.

Response:>

Q_yy_dd_hh:mm:ss.000_

Where: Q = time quality indicator, and may be represented by
_ (a space), meaning it is locked with maximum accuracy.
? (ASCII 63) meaning it is unlocked, accuracy not guaranteed.

Broadcast ASCII plus Quality

Configures to broadcast the time of day as ASCII data appended with a time quality indicator.

Response: <soh>ddd:hh:mm:ssQ >

Where: the start bit of the <soh> is transmitted on time; Q may be represented by, (1) (space) = locked maximum accuracy, (2) . = (ASCII 46), Error < 1 microsecond, (3) * = (ASCII 42) < 10 microseconds, (4) # = (ASCII 35), Error < 100 microseconds, and (5) ? = (ASCII 63) > 100 microseconds.

Broadcast ASCII plus Year

Configures to broadcast the time of day and year as ASCII, appended by a quality indicator.

Response <soh>yyyy_ddd:hh:mm:ssQ >

Where: the start bit of the <soh> is transmitted on time; Q may be represented by, (1) (space) = locked maximum accuracy, (2) . = (ASCII 46), Error < 1 microsecond, (3) * = (ASCII 42) < 10 microseconds, (4)

= (ASCII 35), Error < 100 microseconds, and (5) ? = (ASCII 63) > 100 microseconds.

Broadcast NMEA183GLL

Configures to broadcast the National Marine Electronics Association Standard (NMEA – 183) in GLL format (geographical position, latitude and longitude).

Response: \$GPGLL, llll.llll, a, yyyyy.yyyy, a, hhhmss.sss, A* iD ⤵

Where: GLL = Geographic Position; latitude, longitude (llll.llll = latitude of position), a = N (North) or S (South); yyyyy.yyyy = longitude of position, a = E (East) or W (West); hhhmss.sss in UTC; A = status: A = Active data (A) or Void (V); *iD = checksum.

Broadcast NMEA183ZDA

Configures to broadcast the National Marine Electronics Association Standard (NMEA-183) in ZDA format; it includes ZDA time and date, including the UTC day, month, year, and local time zone.

Response: \$GPZDA, hhhmss.ss, dd, mm, yyyy, ±xx, xx* iD ⤵

Where: ZDA = time and date; hhhmss.ss = UTC time; dd = day (1 – 31), mm = month (1 – 12), yyyy = year, xx,xx = local zone description, 00 to ±13 hours and minutes; *iD = checksum.

Broadcast ABB_SPA_MSG

Configures to broadcast the ABB SPA format – a time string sequence of 32 ASCII characters starting with the characters ">900WD" and ending with a carriage return.

Response: >900WD: yy-mm-dd_hh:mm:ss.fff:cc ⤵

Where: yy-mm-dd = the current date; yy = year of century (00...99), mm = month (1...12), dd = day of month (01...31), _ space (ASCII 20H); hh:mm:ss.fff = current time, hh = hours (0...23), mm = minutes (00...59), ss = seconds (00...59, or 60 while leap second), fff = milliseconds (000...999), cc = checksum; ⤵ = carriage return-linefeed (ASCII 0Dh).

Broadcast PATEK_PHILIPPE_MSG

Configures to broadcast the Patek Philippe message.

Response: T:yy:mm:dd:dw:hh:mm:ss >

Where: dw = day of the week (1...7).

Broadcast KISSIMMEE_MSG

Configures to broadcast the Kissimmee message used for the Telegyr 5700 RTU.

Response: ddd:hh.mm:ssQ<LF><CR>

Where: Q = quality indicator (with indicators as follows); _ (space) = locked, maximum accuracy, . = (ASCII 46) Error < 1 microsecond, * = (ASCII 42) Error < 10 microseconds, # = (ASCII 35) Error < 100 microseconds, ? = (ASCII 63) > 100 microseconds. The string ends with a line feed prior to carriage return. Using custom string characters, this would be /TOA.../HOD.

8.2.4 Com Port Settings

Configure COM2 Port Settings

Command: **2,b,w,s,p,cYB**

Sets the COM2 port settings as follows:

Setting Values

b = baud rate: 0 = 1200, 1 = 2400, 2 = 4800, 3 = 9600, 4 = 19200,
5 = 38400, 6 = 57,600, 7 = 115,200

w = word length: 0 = 7 bits, 1 = 8 bits

s = stop bits: 0 = 1 bit, 1 = 2 bits

p = parity: 0 = off, 1 = even, 2 = odd

c = COM port: 1 = COM2²

Return COM Port Settings

Command: **2,cYB**

Returns the current COM port settings, where c is the COM port; 0 = COM1, 1 = COM2.

Example of returned settings: **UB:3 1 0 0**, from Setting Values it translates to 9600 baud, 8 data bits, 1 stop bit, no parity.

²COM1 set only through dip switches; see page 14

Return Current Custom Broadcast String

Command: **mCB**

Returns current custom broadcast string from either port, where m = 0 for COM1 and m = 1 for COM2.

8.3 Broadcast Commands

8.3.1 Broadcast Mode – Interrogate

Command: **0BR, 1BR**

0BR stops the configured broadcast string (resets to Interrogate Mode) on COM1. 1BR stops the configured broadcast string on COM2.

Response: >

8.3.2 Broadcast Mode – Start Configured String

Command: **1,n,o,0BR, 1,n,o,1BR**

1,n,o,0BR starts the configured broadcast string on COM1. 1,n,o,1BR starts the configured broadcast string on COM2. Set n equal to the desired broadcast interval (in seconds) and o according to the desired time zone (0 = UTC or 1 = Local).

NOTE: to use the custom BR command, you must first install it with the 1095 Utility, or load the string using the @@A or @@B command.

Response: <soh>ddd:hh:mm:ss > (example is Standard ASCII)

8.3.3 Broadcast Mode – Event

Command: **2,n,o,0BR, 2,n,o,1BR**

2,n,o,0BR starts broadcasting event data from COM1 when new data is available. 2,n,o,1BR starts broadcasting event data on COM2 when new data is available. The n variable is ignored. Set o according to the desired time zone (0 = UTC or 1 = Local).

Response: (Local) mm/dd/yyyy hh:mm:ss.ssssss nnnL >
(UTC) mm/dd/yyyy hh:mm:ss.ssssss nnnU >

Where: nnn = Event buffer read index number; U = UTC time; L = Local time

8.4 Event Mode Commands

8.4.1 Return Specific Event

Command: **nED**

nED sets the event buffer Read Index to a specific event number (1 to 300), and returns that event information in either Local or UTC time format depending on how the command, nTA (below) is configured.

Format: n = Event-Buffer Read Index Number; U = UTC Time;
L = Local Time

Response:

LCL mm/dd/yyyy hh:mm:ss.sssssss nnnL >

UTC mm/dd/yyyy hh:mm:ss.sssssss nnnU >

If the event buffer is empty, the "nED" response will be:

Index not active

8.4.2 Set Event Channel Time

Command: **nTA**

nTA sets the time source (1095A/C) to either Local or UTC, where n = 0 sets the event time to UTC and n = 1 sets the event time to Local. TA returns the current setting.

Response: >

8.4.3 Control Event Operation

Command: **m,nEV, EV**

m,nEV controls event operation, where m = 0 sets the Event mode, and m = 1 sets the 1-PPS mode. Set n = 0, unless 123; see below. EV returns a single event from the event buffer.

For example: 0EV sets the Event Mode; 1EV sets the 1-PPS Deviation Mode; 0,123EV clears the event data.

Response: > (No Data – if the event buffer is empty)

8.4.4 Return Deviation for Event Channel

Command: **DA**

DA returns 1-PPS deviation and sigma for the event input.

Response: \pm dddd.dd ssss.ss \rhd (Results are in microseconds)

Format: dddd.dd = the deviation from 1 PPS (GPS), averaged over 16 samples; ssss.ss = the standard deviation (sigma) of samples.

8.5 Status Mode Commands

8.5.1 Status of Event/Deviation

Command: **SA**

SA returns the event/deviation Channel setup information, read index number and write index number.

Response: D(E), R = nnn, S = mmm \rhd

Format: D indicates the input channel is in 1 PPS deviation mode; E indicates the input channel is in Event mode; nnn is Channel read index (001 to 300); mmm is Channel write index (001 to 300).

NOTE: When nnn = mmm, and when using the EA command to read event data, the event buffer is empty (i.e. all event data which has been recorded has also been read).

8.5.2 Clock Status

Command: **SC**

SC returns the current clock status.

Response: L(U), U=xx, S=nn \rhd

Format: L = Clock currently locked to GPS (U for unlocked); xx = Indicates loss of lock period, up to 99 minutes; nn = User specified out-of-lock delay, 00 to 99 minutes (refer to Table A-8); S = Off if the out-of-lock function is deactivated, S = ZDL indicates zero delay.

8.5.3 EEPROM Status

Command: **SE**

SE returns the EEPROM status.

Response: T=t CE=ee \rhd

Format: t = 0, No Timeout Error; t = 1, Timeout Error; ee = Number of corrected errors in reading EEPROM data.

8.5.4 Receiver Status

Command: **SR**

SR returns the current receiver status.

Response: V=vv S=ss T=tt P=Off E=0 >

Format:

vv = Number of satellites, visible to the antenna, per almanac.

ss = relative signal strength (range: 0 to 255, nominal value = 15)

tt = Number of satellites being actively tracked (up to twelve)

P = Off, Indicates that the time dilution of precision (TDOP) calculation is not being performed. Returns 1.0 - 99.0, depending on satellite geometry, when TDOP calculation is being performed. A TDOP calculation is NOT performed if less than 3 satellites are visible, OR if Position-Hold is active. E = 0, currently unused.

8.5.5 Time Quality

Command: **TQ**

TQ returns a single ASCII character (0, 4-9, A, B, F) indicating estimated worst-case time quality, which follows the IEEE Standard, P1344.

Value	Condition, Accuracy	Value	Condition, Accuracy
0	Locked, max. accuracy	8	Unlocked, < 10 ms
4	Unlocked, < 1 μ s	9	Unlocked, < 100 ms
5	Unlocked, < 10 μ s	A	Unlocked, < 1 s
6	Unlocked, < 100 μ s	B	Unlocked, < 10 s
7	Unlocked, < 1ms	F	Unlocked, time not reliable

Response: <Value> >

8.5.6 Fault Message

Command: **FA**

FA returns a string that identifies a fault condition. There are four messages reported by the Model 1095A/C: (1) None, (2) Receiver, (3) Antenna Short, and (4) Antenna Open.

Response: Fault: <message> >

8.6 Time Adjustment Commands

In this section, Daylight Saving/Summer Time is abbreviated as DST.

8.6.1 Return DST Settings

Command: **0DT**

0DT returns the current DST Settings to the current COM port.

Response: (Mode: OFF, ON, or AUTO)

Mode: AUTO >

START:02:00 Second SUN of MAR.>

STOP :02:00 First SUN of NOV.>

8.6.2 Set DST Mode

Command: **1,mDT**

1,mDT activates the DST Mode, where m = 0 to 2, with 0 = OFF, 1 = ON, and 2 = AUTO. When OFF this time adjust feature does not add the specified offset to local time display and output. With m = 1 (ON), the DST feature is always on. With m = 2, the DST feature will automatically change at the specified dates and times. To complete the DST setup, also use the Set DST Auto Start and Stop commands described below.

8.6.3 Set DST Auto Start Time

Command: **2,w,x,y,zDT**

2,w,x,y,zDT sets the date and time when DST starts, where:

w = Month (0, ..., 11); 0 = Jan., 1 = Feb., ..., 11 = Dec.

x = WeekOfMonth (0, ..., 5); 0 = First, 1 = Second, 2 = Third, 3 = Last, 4 = Second from Last, and 5 = Third from Last.

y = DayOfWeek (0, ..., 6); 0 = Sun., 1 = Mon., ..., 6 = Sat.

z = Minutes after midnight z (0 through 1440).

Response: >

8.6.4 Set DST Auto Stop Time

Command: **3,w,x,y,zDT**

3,w,x,y,zDT sets the date and time when DST stops, where:

- w = Month (0, . . . , 11); 0 = Jan., 1 = Feb., . . . , 11 = Dec.
- x = WeekOfMonth (0, . . . , 5); 0 = First, 1 = Second, 2 = Third, 3 = Last, 4 = Second from Last, and 5 = Third from Last.
- y = DayOfWeek (0, . . . , 6); 0 = Sun., 1 = Mon., . . . , 6 = Sat.
- z = Minutes after midnight z (0 through 1440).

Response: >

8.6.5 Set Local Offset

Command: **mLT**

mLT sets the local offset in 15-minute increments for ± 720 minutes (± 12 hours), where m equals the number of minutes, positive (East) or negative (West). LT returns current setting.

Response: >

8.6.6 Set Display Time Mode

Command: **mTD**

mTD sets the display mode to either UTC (m = 0) or Local (m = 1) on Model 1095C clocks only. TD returns current setting.

Response: >

8.7 IRIG Data, IEEE P1344

Command: **m,n,oIR**

m,n,oIR configures the control bits of the IRIG-B IEEE P1344 standard. oIR returns setting, e.g. 0IR returns IRA:0 0 (means Channel A set to IEEE Off and IRIG time set to UTC), where:

- m = 0, IEEE P1344 control bits OFF; m = 1, control bits ON,
- n = 0, IRIG Time = UTC; n = 1, IRIG Time = Local
- o = 0, IRIG Output on Ch A; o = 1, IRIG Output on Ch B.

Response: >

8.8 Position Data Commands

8.8.1 Return Elevation

Command: **LH**

LH returns the current antenna elevation.

Response: `nnnnn.nn` >

Format: Where: Elevation in meters referenced to the WGS-84 datum;
n = -1000.00 to +18000.00 meters.

8.8.2 Return Latitude

Command: **LA**

LA returns the current antenna latitude.

Response: `Ndd:mm:ss.sss` >

Format: N = North (S for South), dd = degrees, mm = minutes,
ss.sss = seconds

8.8.3 Return Longitude

Command: **LO**

LO returns the current antenna longitude.

Response: `Wddd:mm:ss.sss` >

Format: W = West (E for East), ddd = degrees, mm = minutes,
ss.sss = seconds

8.8.4 Set Receiver Position

Command: **d,m,s,D,M,S,hSP**

d,m,s,D,M,S,hSP sets the receiver position based on the following values: negative values are South latitude and West longitude, positive values are North latitude and East longitude.

d = degrees latitude, m = minutes latitude, s = seconds of latitude,
D = degrees of longitude, M = minutes of longitude, S = seconds of longitude, h = height (\pm meters)

Response: >

8.9 Date and Time Commands

8.9.1 Set Receiver Time

Command: **yyyy:MM:dd:hh:mmTS**

... TS sets the receiver (UTC) time when not locked to the GPS. The command is ignored when the Model 1095A/C is locked to satellites. When the receiver is initially activated, and has not locked onto satellites, acquisition time may be improved by giving the clock an initial estimate of UTC time, which it can use (with stored position and almanac data) to determine which satellites and Doppler shifts to use in acquisition.

Format: yyyy = year; MM = month; dd = day; hh = hour; mm = minute

Response: >

8.9.2 Return Local Date & UTC Date

Command: **DL, DU**

DL returns the current Local date. DU returns the current UTC date.

Response: ddmmmyyyy >

8.9.3 Return Local Time & UTC Time

Command: **TL, TU**

TL returns the current Local time. TU returns the current UTC time.

Response: ddd:hh:mm:ss >

NOTE: The DL, DU, TL and TU command formats are identified as follows:

Format:

yyyy = year

dd = day of month

hh = hour

mm = minute

ss = second

mmm = month (JAN DEC)

ddd = day of year

8.10 Programmable Pulse Commands

8.10.1 Set Pulse Width

Command: **m,nPW**

m,nPW configures the Programmable Pulse output pulse width in seconds, where m = 0 through 8,640,000 in 10 millisecond increments (gives you from 0 to 24 hours). n = 0 for Prog Pulse A, = 1 for Prog Pulse B. nPW returns current setting, e.g. 0PW returns PWA:100, which means 100 10-millisecond increments (or 1 second).

Response: >

8.10.2 Set Programmable Pulse Output Mode

Command: **m,nPM**

m,nPM configures the programmable pulse mode (m) and output port (n). Programmable Pulse A can accept modes m = 0 and 1, Programmable Pulse B can accept four modes: 0, 1, 2, and 3. nPM returns current setting. Values for m and n are:

m = 0, Pulse OFF; = 1, Pulse Mode; = 2, Frequency Mode; = 3, Aux IIRIG Mode; n = 0, Timing Output A; = 1, Timing Output B

Response: >

8.10.3 Set Alarm Time Mark

Command: **d,h,m,s,hs,oAL**

...AL sets the date and time at which the Model 1095A/C issues the programmable pulse. d, h, m, s and hs set the output pulse to be generated at the next occurrence of the specified time and date. o = 0 sets the output to Programmable Pulse A; 1, to programmable Pulse B. oAL returns current setting.

Format: d = day of year (1 through 366)

h = hour (0 through 23)

m = minute (0 through 59)

s = second (0 through 59)

hs = fractional seconds in 0.01 increments (00 through 99)

o = Programmable Pulse A or B; 0 = A, 1 = B

Response: >

8.10.4 Set Programmable Pulse-Mode Type

Command: **m,nPT**

m,nPT configures the programmable pulse mode type, where m = 0 through 6 are the types, and n = 0 for Prog. Pulse A and n = 1 for Prog. Pulse B. For programming details, see Figure 2.2, Section 4.13 and Section 4.14. nPT returns current setting.

Format: m = 0 Pulse per Second; = 1, Pulse per Minute; = 2, Pulse per Hour; = 3, Pulse per Day; = 4, Single Trigger; = 5, Slow Code; = 6, Seconds per Pulse

Response: >

8.10.5 Set Programmable Pulse Delay

Command: **m,nPD**

m,nPD sets the delay between pulses for Seconds-Per-Pulse mode, where m selects the number of seconds in 10 millisecond increments (up to 60,000 seconds); n = 0 selects Prog. Pulse A and n = 1 selects Prog. Pulse B. For example, to set Prog. Pulse A seconds-per-pulse mode for a pulse every 10 minutes (or 600 seconds), use the following command: 60000,0PD. nPD returns current setting.

Response: >

8.10.6 Set Pulse Polarity

Command: **m,nPP**

m,nPP sets the programmable pulse transition polarity (i.e. TTL, CMOS high or low). m = 0, positive and m = 1, negative; n = 0 and 1, with 0 = Programmable Pulse A and 1 = Programmable Pulse B. nPP returns current setting.

Response: >

8.10.7 Set Output Frequency

Command: **mPF**

mPF sets the programmable pulse output frequency from 1 to 1000 pulses per second, where m = the frequency in pulses per second. Used with Prog. Pulse B, Frequency Mode. PF returns current setting.

Response: >

8.10.8 Set Time Selection

Command: **m,nPS**

m,nPS sets the programmable pulse time selection to either UTC or Local, where m = 0 for UTC and m = 1 for Local; n = 0 for Prog Pulse A, n = 1 for Prog Pulse B. nPS returns current setting.

Response: >

8.11 Miscellaneous Commands

8.11.1 Set Antenna Delay

Command: **nnnnnnAD**

...AD sets antenna system delay compensation value. NOTE: Factory default setting for the standard 6-meter (20-foot) cable is 24 ns. Time range is from 0 to 999999 nanoseconds. The exact syntax for a 24-ns delay is 24AD. See Section 7.1.3 for information on calculating cable delay. AD returns current setting.

Response: >

8.11.2 Set Out-of-Lock Time

Command: **(-)nLK**

(-)nLK configures the Out-Of-Lock function in the Model 1095A/C. A negative number turns the out-of-lock function OFF. n = 0 sets the out-of-lock time to zero delay. n = 1 to 99 sets the amount of delay time (in minutes) following loss of satellite synchronization before an out-of-lock signal is generated and the relay contacts change state. LK returns current setting.

Response: >

8.11.3 Return Firmware Version

Command: **VE**

VE returns the Firmware Revision date of the installed ROM.

Response: dd mmm yyyy >

Where, dd = day of month, mmm = month, yyyy = year

8.11.4 Select Survey Mode

Command: **mSS**

mSS sets the survey mode to either Turn Survey mode Off or to set for Power On Survey, where m = 0 for Turn Off Survey, m = 1 for Power On Survey. SS returns current setting.

Response: >

8.11.5 Set Relay Output Mode

Command: **mRM**

Sets the relay output mode, where m = 0, ..., 5; 0 = Fault; 1 = Out of Lock; 2 = Programmable Pulse A; 3 = Programmable Pulse B; 4 = Stabilized (time); 5 = Event in. RM returns the current setting.

Response: >

8.11.6 Set RS-485 Data Output Mode

Command: **mDO**

mDO sets RS-485 data output mode, where m = 0, ..., 7; 0 = TxD A; 1 = TxD B; 2 = IRIG-B; 3 = Programmable Pulse A; 4 = Programmable Pulse B; 5 = 1 PPS; 6 = Unlocked; 7 = Event In. DO returns current setting.

Response: >

8.11.7 Set Display Mode

Command: **m,nLE**

Sets the display mode on the Model 1095C only. mLE (m = 0, ..., 5) sets the mode as follows: m = 0, Display off; = 1, Display on; = 2, Auto Brightness. m,nLE sets the brightness value with m = 1 and n = 1, ..., 180 (must use both m and n for manual brightness control).

Response: >

Appendix A

CE Mark Declaration

Date of Issue: October 1, 2008

Directives: 89/336/EEC Electromagnetic Compatibility
73/23/ EEC Low Voltage Safety

Model Number: 1095A Industrial GPS Clock

Manufacturer: Arbiter Systems, Inc.
1324 Vendels Circle, Suite 121
Paso Robles, CA 93446 – USA

Harmonized EN55011 Class A, Radiated and Conducted
Emissions

Standard EN50082-1 Generic Immunity, Part 1
Referenced: Residential, Commercial and Light Industrial
Environments

EN61010-1 Safety requirements of Electrical
Equipment for Measurement, Control
and Laboratory Use.

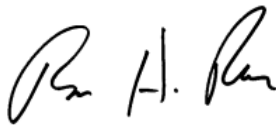

Signed: _____
Signatory: Bruce H. Roeder

This certificate declares that the described equipment conforms to the applicable requirements of the directives on Electromagnetic Compatibility 89/339/EEC, Safety 73/23/EEC, and amendments by 93/68/EEC adopted by the European Union.

APPENDIX A, continued

Date of Issue: October 1, 2008
Directives: 89/336/EEC Electromagnetic Compatibility
73/23/ EEC Low Voltage Safety
Model Number: 1095C Industrial GPS Clock
Manufacturer: Arbiter Systems, Inc.
1324 Vendels Circle, Suite 121
Paso Robles, CA 93446 – USA
Harmonized EN55011 Class A, Radiated and Conducted
Emissions
Standard EN50082-1 Generic Immunity, Part 1
Referenced: Residential, Commercial and Light Industrial
Environments
EN61010-1 Safety requirements of Electrical
Equipment for Measurement, Control
and Laboratory Use.

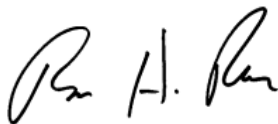

Signed: _____
Signatory: Bruce H. Roeder

This certificate declares that the described equipment conforms to the applicable requirements of the directives on Electromagnetic Compatibility 89/339/EEC, Safety 73/23/EEC, and amendments by 93/68/EEC adopted by the European Union.

Appendix B

Statement of Compliance

October 1, 2008

TO WHOM IT MAY CONCERN:

All Arbiter Systems, Incorporated G.P.S. Satellite Controlled Clocks are Primary Standards. They provide time traceable to U.T.C. and U.S.N.O. within published accuracy specifications anywhere in the world. All Arbiter Systems Incorporated G.P.S. Satellite Controlled Clocks also carry a limited lifetime warranty, which is based on in field MTBF (Mean Time Between Failures) of over one million (1,000,000) hours. These products are available with all known time synchronization signals presently in use world wide by the electric power industry.

Arbiter Systems does not supply a type test certificate as requested for G.P.S. systems as the accuracy is a function of the G.P.S. system and not of the receiver. However we (Arbiter) hereby certify that this equipment conforms to all Arbiter Systems Incorporated specifications for material and process. All Arbiter Systems calibration products are supplied with a type test certificate guaranteeing traceability to National Standards, but are inappropriate for G.P.S. clocks, which are Primary Standards by definition.

Regards,

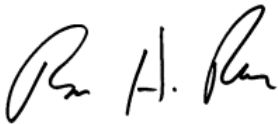

Bruce H. Roeder
International Marketing Manager
Arbiter Systems, Inc.
BHR/sc

Index

- 1 PPS
 - description, 46
- 1095A startup, 23
- 1095A/C software
 - connecting, 27
 - display setup, 37
 - prog pulse A, 35
 - prog pulse B, 36
 - reading clock config, 29
 - serial parameters, 32
 - system parameters, 30
 - time adjustment, 33, 34
 - USB-to-Serial adapters, 28
- 1095C startup, 24
- accessory cables, 65
- analog drivers, 43
- antenna
 - clock connection, 66
 - connection, 66
 - external, 12
 - internal, 11
 - mounting assembly, 20
 - mounting kit, 20
 - mounting procedure, 20
 - pipe-mount dimensions, 63
 - power supplied to, 66
 - user-supplied cables, 66
- antenna cable, 63
 - effects of cable parameters, 63
- antenna/cable testing, 67
- Appendix
 - A, 94
 - B, 96
- cable
 - accessory, 65
 - adjacent signal interference, 66
 - attenuation, 64
 - Belden, 12
 - DC resistance, 64
 - delay, 64
 - delays, 50
 - distance, 47
 - main functions, 12
 - physical protection, 65
 - timing output, 47
 - user-supplied, antenna, 66
 - wire losses, 49
 - wiring 1095A/C, 12
- CE Mark Declaration, 94
- COM ports, 70
- configure clock
 - COM parameters, 32
 - connect, 27
 - display, 37
 - IRIG-B, 34
 - open new configuration, 38
 - prog pulse A, 35
 - prog pulse B, 36
 - read configuration, 29
 - save config file, 38
 - system, 30
 - time adjustment, 33

- tutorial, 26
- usb-to-serial adapter, 28
- using terminal programs, 39
- connecting
 - modulated IRIG-B, 49
 - outputs, 47
 - unmodulated IRIG-B, 48
- Daylight Saving Time, 33
- deviation
 - measurement, 52
 - measurement principle, 52
- digital drivers, 43
- DIP switches, 14
- drive current vs. output voltage, 43
- driver
 - analog, 43
 - digital, 43
- event inputs, 51
 - channel configuration, 53
 - timing principle, 52
- events
 - clear event buffer, 31, 83
- fault
 - messages, 25
 - 1095A, 25
 - 1095C, 25
- fuse
 - location, 12
 - specification, 15
- gps
 - orbits, 17
 - surge arrester, 16, 67
 - tracking, 17
- HyperTerminal, 39
- IRIG-B
 - IEEE 1344 description, 46
 - modulated
 - voltage matching, 50
 - time code types, 44
 - timecode description, 44
 - unmodulated, 45
 - waveform comparison, 45
- port, I/O
 - definitions, 13
 - locations, 13
- programmable pulse
 - description, 46
 - pulse width, 46
- programming cable kit, 2
- relay
 - configuration, 30
 - contacts, 14
 - output mode, 93
 - set out-of-lock, 92
 - specifications, 58
 - terminals, 43
- RS-232C Communication, see serial command
- serial command
 - antenna delay
 - set, 92
 - broadcast
 - custom, 72
 - broadcast strings, 72
 - broadcast, interrogate, 82
 - config custom, 82
 - config event, 82
 - DST/Summertime
 - activate, 86
 - return settings, 86
 - start time, 86
 - stop time, 87
 - Event
 - channel time, 83
 - control operation, 83
 - number, 83
 - return deviation, 83

- Local Offset, 87
- out-of-lock alarm
 - set time, 92
- Prog Pulse
 - pulse delay, 91
 - pulse frequency, 91
 - pulse polarity, 91, 92
 - set mode, 90
 - set pulse width, 90
 - set time mark, 90
- return
 - elevation, 88
 - firmware version, 92
 - latitude, 88
 - local date, 89
 - local time, 89
 - longitude, 88
- set
 - display mode, 93
 - display time, 87
 - IEEE 1344 mode, 87
 - receiver position, 88
 - receiver time, 89
 - relay output mode, 93
 - RS-485 output mode, 93
- Status
 - clock, 84
 - EEPROM, 84
 - event/deviation, 84
 - faults, 85
 - receiver, 85
 - time quality, 85
- survey
 - mode, 93
 - selection, 93
- UTC date, 89
- UTC time, 89
- serial connection kit, 8
- serial port
 - output symbols, 71
- signal
 - output description, 44
- software
 - 1095 Utility Application, 26
 - opening configuration file, 38
 - saving configuration file, 38
- specifications, 55
 - certifications, 62
 - communications, 58
 - environmental, 62
 - general, 62
 - GPS receiver, 55
 - inputs & outputs, 56
 - interface, 58
 - physical, 62
 - power requirements, 62
 - relay, 58
- startup
 - 1095A, 23
 - 1095A fault display, 25
 - 1095C, 24
 - 1095C fault display, 25
- Statement of Compliance, 96
- surge arrester, 67
- switch
 - DIP, COM1, 14
- synchronizing
 - multiple devices on one port, 48
- Tera Term Pro, 40
- terminal programs
 - HyperTerminal, 39
 - Tera Term Pro, 40
- timing outputs
 - description, 42
 - intro, 41
- unpacking the clock, 1
- Using External Antennas, 63
- wiring connections, 12