

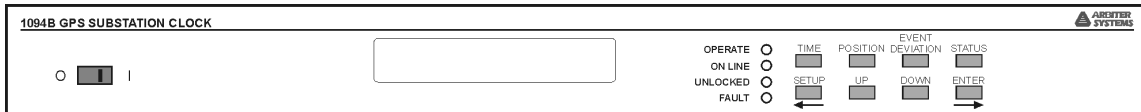

MODEL 1094B GPS SUBSTATION CLOCK

OPERATION MANUAL



ARBITER SYSTEMS, INC.
PASO ROBLES, CA 93446
U.S.A.
WWW.ARBITER.COM

Description

This manual is issued for reference only, at the convenience of Arbiter Systems. Reasonable effort was made to verify that all contents were accurate as of the time of publication. Check with Arbiter Systems at the address below for any revisions made since the original date of publication.

Contact Information

Arbiter Systems, Inc.
1324 Vendels Circle, Suite 121
Paso Robles, CA 93446
USA
(805) 237-3831
Website: www.arbiter.com
techsupport@arbiter.com
sales@arbiter.com

What This Manual Covers

This manual describes the set up and operation of the Model 1094B GPS Substation Clock.

Firmware Dates

This version of the manual is written for clocks having firmware dates of 5 December 2011 or later. Any changes made in subsequent revisions which affect operation or specifications will be noted with either (a) a new manual or (b) a revised version of this manual. To display the firmware version or date for your instrument using the 1094 Utility application, see Section 6.6.10. The firmware version may also be viewed using “VE” command in a terminal window; see Section 10.3.15, Miscellaneous Commands in Chapter 10.

Firmware Updates

Firmware updates are available to customers by download from the Arbiter Systems website. Go to www.arbiter.com and select Software Downloads under the Site Navigation (on the left). Then, scroll down to Timing Software and select Model 1094B Software. For service, contact our factory at Contact Information listed above. Electronic versions of this manual are also available on the Arbiter website under Site Navigation, PDF Manuals and Datasheets.

LIMITED WARRANTY

Arbiter Systems makes no warranty, expressed or implied, on any product manufactured or sold by Arbiter Systems except for the following limited warranty against defects in materials and workmanship on products manufactured by Arbiter Systems.

Clock products manufactured by Arbiter Systems are guaranteed against defective materials and workmanship under normal use and service from the date of delivery for the period listed as ten (10) years from date of delivery. Arbiter Systems will repair or replace the defective component as long as components are available and for no more than five years after the product has been deemed obsolete. The responsibility of Arbiter Systems under this warranty is limited to repair or replacement, at Arbiter Systems' option, of any product found to be defective. Arbiter Systems shall have no liability under this warranty unless it receives written notice of any claimed defect.

For warranty service or repair, products must be returned to a service facility designated by Arbiter Systems. Buyer shall prepay all shipping charges, duties, and taxes to send the product to Arbiter Systems and Buyer shall prepay shipping charges, duties, and taxes to return the product to Buyer. THE WARRANTY SET FORTH HEREIN CONSTITUTES THE ONLY WARRANTY OBLIGATIONS OF ARBITER SYSTEMS, EXPRESSED OR IMPLIED, STATUTORY, BY OPERATION OF LAW, OR OTHERWISE. ARBITER SYSTEMS DISCLAIMS ANY WARRANTY OF MERCHANTABILITY OR FITNESS FOR A PARTICULAR PURPOSE, AND BUYER EXPRESSLY WAIVES ALL OTHER WARRANTIES.

This limited warranty does not extend to any product, which has been subject to

1. Improper use or application, abuse, or operation beyond its rated capacity, or contrary to the instructions in the operation and maintenance manuals (if any);
2. Accident;
3. Repair or maintenance performed by Buyer, except in accordance with the operation and maintenance manuals, if any, and any special instructions of Arbiter Systems;
4. Modification without the prior written authorization of Arbiter Systems (whether by the substitution of non-approved parts or otherwise). The remedies provided herein are Buyer's sole and exclusive remedies. In no event shall Arbiter Systems be liable for direct, indirect, incidental or consequential damages (including loss of profits), whether based on contract, tort, or other legal theory.

FOR THE FASTEST POSSIBLE SERVICE, PLEASE PROCEED AS FOLLOWS:

1. Notify Arbiter Systems, Inc., specifying the instrument model number and serial number and giving full details of the difficulty. Service data or instrument-return authorization will be provided upon receipt of this information.
2. If instrument return is authorized, forward prepaid to the manufacturer. If it is determined that the instrument is not covered by this warranty, an estimate will be made before the repair work begins, if requested.

See Contact Information on page ii.

Model 1094B

GPS Substation Clock

Operation Manual

Chapter 1	Unpacking the Clock
Chapter 2	Front and Rear Panels
Chapter 3	Connecting Inlet Power
Chapter 4	Antenna and Cable Information
Chapter 5	Setting Internal Jumpers
Chapter 6	Startup and Application Software
Chapter 7	The Setup Menus
Chapter 8	Timing, IRIG-B, and Pulses
Chapter 9	Relay Contacts and Event Inputs
Chapter 10	Serial Communication and Commands
Appendix A	Technical Details and Specifications
Appendix B	Using Surge Arresters
Appendix C	Statement of Compliance
Appendix D	Switching High Voltage Signal Lines
	Index

Copyright Arbitr Systems Incorporated November 2025. All rights reserved. International copyright secured.

PD0036600X

Contents

1	Unpacking the Clock	1
1.1	Introduction	1
1.2	Precautions	1
1.3	Unpacking and Locating Accessories	2
1.4	Attaching Rack-Mount Ears to Clock	2
1.4.1	Mounting Instructions	3
1.5	Mounting Antenna and Antenna Cable	3
2	Front and Rear Panels	4
2.1	Introduction	4
2.2	Front Panel Controls and Indicators	4
2.2.1	Annunciator LED Definitions	5
2.2.2	LCD Display	5
2.2.3	Command Key Definitions	5
2.3	Rear Panel Identification and Connectors	7
2.3.1	Power Inlet	7
2.3.2	Antenna Input	8
2.3.3	Event Input	9
2.3.4	RS-232 and RS-485 Communication Ports	9
2.3.5	Form C Relay Contacts	9
2.3.6	Timing Outputs	10
3	Connecting Inlet Power	11
3.1	Option 07, IEC-320 Power Inlet Module (RoHS)	11
3.1.1	Cordsets and Plug Styles for Option 07	12
3.1.2	Option 07, Connecting Power to the 1094B	12
3.2	Option 08, 10 Vdc to 60 Vdc Power Inlet Module (RoHS)	12
3.2.1	Option 08, Connecting Inlet Power	13
3.3	Option 10, 110 Vdc to 350 Vdc Terminal Power Strip, Surge Withstand (RoHS)	13
3.3.1	Option 10, Connecting Inlet Power	13
3.4	Fuse Locations and Types	13
3.4.1	Replacing Fuses	14
4	GPS Antenna and Cable Information	15
4.1	GPS Antenna Installation	15
4.1.1	Mounting the Antenna	15

4.1.2	Optional Antenna Mounting Kit, P/N AS0044600	16
4.2	Verifying Antenna and Cable Operation	18
4.2.1	GPS Signal Strength	18
4.2.2	Checking the Antenna Voltage	18
4.2.3	Power Supply Check	18
4.2.4	Checking the Antenna Resistance	18
4.3	GPS Surge Arrester	18
4.3.1	Using the GPS Surge Arrester	19
4.4	Technical Details on GPS, Antennas and Cables	19
4.4.1	Antenna Cable	19
5	Setting Internal Jumpers	22
5.1	Introduction	22
5.1.1	Jumper Locations	22
5.1.2	List of Default Jumper Positions and Functions	23
5.2	Configuring Output Jumpers	23
5.2.1	Configuration Notes	24
5.3	Configuring Relay Mode Jumpers	24
5.3.1	Relay Contact Specifications	24
5.4	Configuring Communication Port Jumpers	24
5.5	Configuring Event Input Jumpers	25
5.5.1	Selecting the Event Input Channel and Voltage	25
5.5.2	Configuring the Event/1-PPS Function	26
6	Clock Startup and Utility Software	27
6.1	Initial Startup Sequence	27
6.1.1	Clock Time, Startup Mode	27
6.2	Front Panel Indication	28
6.2.1	LCD Display Indication at Startup	28
6.2.2	Other Display Indications When Unlocked	28
6.2.3	Status Display Indications	29
6.2.4	Event/Deviation Display	29
6.2.5	IRIG-B Time Data	30
6.3	Clock Status Display Mode	30
6.4	Time Display Modes	30
6.4.1	Date and Time Display, Universal Time Coordinated (UTC)	30
6.4.2	Time of Year Display, Universal Time Coordinated, (UTC)	31
6.4.3	Date and Time Display, Local Time	31
6.4.4	Time of Year Display, Local Time	31
6.4.5	Daylight Saving-Summer Time	32
6.5	Position Display Modes	32
6.5.1	Longitude Display	32
6.5.2	Latitude Display	32
6.5.3	Elevation Display	32
6.6	Application Software – 1094B Utility	33
6.6.1	Configuring with 1094B Utility Software	33

6.6.2	Establishing a Serial Connection	34
6.6.3	Reading Clock Configuration	36
6.6.4	The System Screen	37
6.6.5	The Communication Screen	39
6.6.6	The Time Screen	40
6.6.7	The IRIG-B Screen	41
6.6.8	The Programmable Pulse A Screen	42
6.6.9	The Programmable Pulse B Screen	43
6.6.10	The Version Screen	44
6.6.11	Setting to Factory Defaults	44
6.6.12	Saving a Configuration File	45
6.6.13	Opening a New Configuration	45
6.7	Uploading New Firmware using the 109x Loader	45
6.7.1	Using the Uploader	45
7	The Setup Menus	47
7.1	Setup Menus	47
7.1.1	To Begin Configuring	48
7.1.2	Numeric Data Entry Mode	48
7.1.3	Default Firmware Settings	48
7.1.4	To Exit Setup Menus	48
7.2	Set Serial COM1	49
7.3	Set Serial COM2	49
7.3.1	Set Broadcast Mode from Serial COM1	50
7.3.2	Configure Serial COM1 Port Parameters	51
7.4	Set Local Offset	51
7.5	Set DST/Summer Time	52
7.6	Set Out of Lock	53
7.7	Set Backlight	53
7.8	Set Cable Delay	54
7.9	Set Programmable Pulse A and B	55
7.9.1	Programmable Pulse A	55
7.9.2	Programmable Pulse B	55
7.9.3	Programmable Pulse Signal Levels	55
7.9.4	Programmable Pulse A or B Preliminary Setup	56
7.9.5	Setting the Pulse-Per-Second Mode	56
7.9.6	Setting the Pulse-Per-Minute Mode	57
7.9.7	Setting the Pulse-Per-Hour Mode	57
7.9.8	Setting the Pulse-Per-Day Mode	58
7.9.9	Setting the Single-Trigger Mode	58
7.9.10	Setting the Slow-Code Mode	59
7.9.11	Setting the Seconds-Per-Pulse Mode	59
7.9.12	Setting the Frequency Mode, Programmable Pulse B	60
7.9.13	Setting the Aux IRIG Mode, Programmable Pulse B	60
7.10	Set IRIG-B Main	61
7.11	Set Auto Survey	62

7.12	Set Event/Deviation	63
7.12.1	Technical Details of Event/Deviation Timing	63
8	Timing, IRIG-B and Pulses	64
8.1	Introduction	64
8.2	Timing Output Description	64
8.2.1	Standard Inputs and Outputs	64
8.2.2	Digital Drivers – 250 mA Per Channel	65
8.2.3	Analog Drivers	65
8.3	Output Signal Description	66
8.3.1	IRIG-B Description	66
8.3.2	Modulated and Unmodulated IRIG-B	67
8.3.3	IRIG-B IEEE 1344 Extension	67
8.3.4	1 Pulse per Second (1 PPS)	67
8.3.5	Programmable Pulse (Prog. Pulse)	68
8.3.6	Programmable Pulse with 300-Volt FET, Setup	68
8.3.7	300-Volt FET Connection – Setup and Protection	68
8.4	Connecting Outputs	69
8.4.1	Attaching Cables to Screw Terminals	69
8.4.2	How Far Can I Run IRIG-B Cabling?	69
8.4.3	Synchronizing Multiple Devices From One Masterclock Output	69
8.4.4	Connecting Unmodulated IRIG-B	69
8.4.5	Connecting Modulated IRIG-B	70
8.4.6	Wire Losses	70
8.4.7	Voltage Matching for Modulated IRIG-B	71
8.4.8	Cable Delays	71
8.4.9	Solutions	72
9	Relay Contacts and Event Inputs	73
9.1	Introduction to Relay Operation	73
9.2	Configuring	73
9.3	Fault Conditions	73
9.4	Viewing the Fault Status	73
9.5	Connecting to the Multimode Relay	74
9.5.1	Relay Contact Operation	74
9.6	Introduction to Event Inputs	74
9.7	Event Timing Inputs	74
9.7.1	Event Timing – Latency	74
9.7.2	Deviation Measurement	75
9.7.3	Measurement Principle	75
9.7.4	Event Timer Input Channel Configuration	75
9.7.5	Configuring Event/Deviation Operation	75
9.7.6	Accessing or Displaying Event Data	76
9.7.7	Clearing Events	77

10	Serial Communication and Commands	79
10.1	Introduction	79
10.2	Communication Port Information	79
10.3	Command Set	80
10.3.1	Configuring Custom Broadcast Strings	80
10.3.2	Broadcast Mode Overview	83
10.3.3	COM Port Settings	83
10.3.4	Broadcast Commands	84
10.3.5	Event Mode Commands	90
10.3.6	Status Mode Commands	91
10.3.7	Local / Daylight Saving Time Setup Commands	92
10.3.8	Front Panel Control Commands	93
10.3.9	IRIG-B Data Output Commands	94
10.3.10	Position Data Commands	94
10.3.11	Date and Time Commands	95
10.3.12	Programmable Pulse Output Commands	96
10.3.13	Antenna System Delay Commands	98
10.3.14	Out-of-Lock Commands	98
10.3.15	Miscellaneous Commands	98
A	Technical Specifications and Operating Parameters	100
A.1	Introduction	100
A.2	Receiver Characteristics	100
A.2.1	Input Signal Type & Frequency	100
A.2.2	Timing Accuracy	100
A.2.3	Internal Oscillator	100
A.2.4	Position Accuracy	100
A.2.5	Satellite Tracking	100
A.2.6	Acquisition	101
A.3	I/O Configuration	101
A.3.1	Timed Outputs	101
A.3.2	I/O Connectors	101
A.3.3	Standard Output Signals	101
A.3.4	Input Functions	101
A.3.5	Event Input Timing	101
A.4	SPDT Relay Specifications	102
A.5	Systems Interface	102
A.5.1	RS-232C COM1 and COM2	102
A.5.2	Communication Parameters	102
A.5.3	Broadcast Data Formats	102
A.5.4	Antenna System	102
A.5.5	Antenna Cable	102
A.5.6	Operator Interface	103
A.5.7	Setup Functions	103
A.5.8	Display	103
A.5.9	Display Functions	103

A.5.10	Annunciators - LEDs	103
A.6	Physical Specifications	103
A.6.1	Dimensions	103
A.6.2	Weight	103
A.6.3	Power Requirements	104
A.6.4	Power Connector	104
A.6.5	Electromagnetic Interference	104
A.6.6	Temperature and Humidity	104
B	Using a Surge Arrester	105
B.1	Introduction	105
B.2	Description	105
B.3	Installation	105
B.3.1	Mounting Location	105
B.3.2	Ground Connection	105
B.3.3	Antenna and Clock Connections	106
B.3.4	Weather Sealing the Connections	106
B.3.5	Suggested Mounting	106
B.4	Physical Dimensions	106
C	Statement of Compliance	108
C.1	Introduction	108
D	Switching High Voltage Signals	110
D.1	Introduction	110
D.2	Example 1: 300-Volt FET Pull Down	110
D.2.1	Logging Requirements and Circuit Notes	111
D.3	Example 2: 300-Volt FET with Voltage Source in Series	111
D.3.1	Logging Requirements and Circuit Notes	111
D.3.2	Configuring for 300-Volt FET Pull Down	111
D.4	Example 3: 5 Volt Switching with External Relay	112
D.4.1	Configuring for 5-Volt CMOS	112

List of Figures

1.1	Packaging of Accessories	2
1.2	Attaching Rack-Mount Ears	3
2.1	Front Panel Description	4
2.2	Rear Panel Description	7
2.3	Option 07 Power Supply (RoHS)	7
2.4	Option 08 Power Supply (RoHS)	8
2.5	Option 10 Power Supply (RoHS)	8
2.6	GPS Antenna Connector	8
2.7	Event Input Connector	9
2.8	Communication Port Connectors	9
2.9	Relay Contact Connectors	9
2.10	Timing Connectors, IRIG-B and Pulse	10
3.1	Option 07 Power Supply Inlet Description	11
3.2	Option 08 Power Supply Inlet Description	12
3.3	Option 10 Power Supply Inlet Description	13
4.1	Antenna Assembly for Mounting	16
4.2	Antenna Mounting Bracket	17
4.3	Antenna Mounting with AS0044600	17
4.4	GPS Surge Arrester	18
5.1	Mainboard Jumper Locations	22
6.1	1094B Utility Software, Opening Window	33
6.2	Connecting with the 1094B	34
6.3	Windows XP Device Manager – identify COM port	35
6.4	COM Port Assignment, Windows XP	35
6.5	Reading the 1094B Configuration	36
6.6	Reading the 1094B, System Screen	37
6.7	Clearing Events in the 1094B	38
6.8	Communication Settings Screen	39
6.9	Time Adjustment Screen	40
6.10	IRIG-B Adjustment Screen	41
6.11	Programmable Pulse A Setup Screen	42
6.12	Programmable Pulse B Setup Screen	43

6.13	1094B Version Display Screen	44
6.14	1094B Loader with Opened Firmware File	46
6.15	Successful Upload of New Firmware	46
7.1	COM1 Setup	49
7.2	COM2 Setup	49
7.3	Broadcast Mode Setup	50
7.4	COM1 and COM2 Parameter Setup	51
7.5	Local Time Setup	51
7.6	Daylight Saving and Summer Time Setup	52
7.7	Out-of-Lock Time Setup	53
7.8	Backlight Setup	53
7.9	Cable Delay Setup	54
7.10	Programmable Pulse Setup, Preliminary Information	56
7.11	Programmable Pulse Setup, Pulse Per Second	56
7.12	Programmable Pulse Setup, Pulse Per Minute	57
7.13	Programmable Pulse Setup, Pulse Per Hour	57
7.14	Programmable Pulse Setup, Pulse-Per-Day Mode	58
7.15	Programmable Pulse Setup, Single-Trigger Mode	58
7.16	Programmable Pulse Setup, Slow-Code Mode	59
7.17	Programmable Pulse Setup, Seconds-Per-Pulse Mode	59
7.18	Programmable Pulse Setup, Frequency Mode	60
7.19	Programmable Pulse Setup, Aux IRIG-B Mode	60
7.20	IRIG-B Configurations	61
7.21	Auto Survey Configurations	62
7.22	Event Configurations	63
8.1	Rear Panel Description	65
8.2	IRIG-B Waveforms	67
9.1	Rear Panel Relay Contact location and Connector Plug	74
B.1	Suggested Mounting of the AS0094500	107
D.1	300-Volt FET with Pull-Down Resistor	110
D.2	300-Volt FET with Voltage Source in Series	111
D.3	5 Volt Switching with Isolation Relay	112

List of Tables

2.1	Annunciator LED Definitions	5
2.2	Fault Indications and Definitions	5
2.3	Command Key Definitions	6
3.1	Available IEC-320 Cordsets by Country	12
3.2	Fuse Chart	13
4.1	Antenna Mounting Kit Parts List	16
4.2	GPS Cable Data and Accessory Information	20
5.1	Default Mainboard Jumper Settings	23
5.2	Timing Output Jumper Selection	23
5.3	Relay Jumper Positions	24
5.4	Communication Port Jumper Selection	25
5.5	Event Input Voltage Selection	25
5.6	Event Input Connector Selection	26
7.1	Front-Panel Setup Menus	47
7.2	Default Firmware Settings	49
8.1	Drive Current vs. Voltage	65
8.2	IRIG-B Time Code, Types Available	66
8.3	Programmable Pulse Output Functions	68
10.1	COM1 and COM2 Pin Definitions	79
10.2	Custom String Character Table	81
10.3	NGTS Data Message Content	89
A.1	COM1 and COM2 Pin Definitions	102
A.2	Specified Temperatures	104

Chapter 1

Unpacking the Clock

1.1 Introduction

This section will assist you with unpacking the clock from its shipping container; standard accessories shipped with the clock include:

- 1094B GPS Clock (includes internal power supply)
- Antenna Cable, 50 feet with Type F connectors
- GPS Antenna
- Rack-Mount Ears, 2 ea.
- 1094B Operation Manual

1.2 Precautions

Mechanical Shock Note that the GPS antenna is small and smooth, and can be damaged if dropped. Use care when handling. Remember to store the antenna in a safe place before the final installation.

Static Discharge Note that the Model 1094B is an electronic device and uses static-sensitive components in its operation. Therefore, use care when handling against static discharges. Generally, these components are protected in their normal situation, however some of these are accessible when the cover is removed.

CAUTION Antenna Input Connector - Connect only the antenna cable coming from the antenna into this connector. The antenna input connector on the clock itself leads to the GPS receiver, which could be damaged from high voltage or a static discharge.

1.3 Unpacking and Locating Accessories

The Model 1094B and included accessories are packed between two closed-cell foam shells. Carefully pull apart the two shells to extract the clock and accessories. Some of the accessories (i.e. antenna and rack-mount ears) are located in one of these shells for protection. In the diagram below, you can see how the GPS antenna and rack-mount ears are located in the closed-cell foam marked with the label that reads,

ADDITIONAL PARTS INSIDE

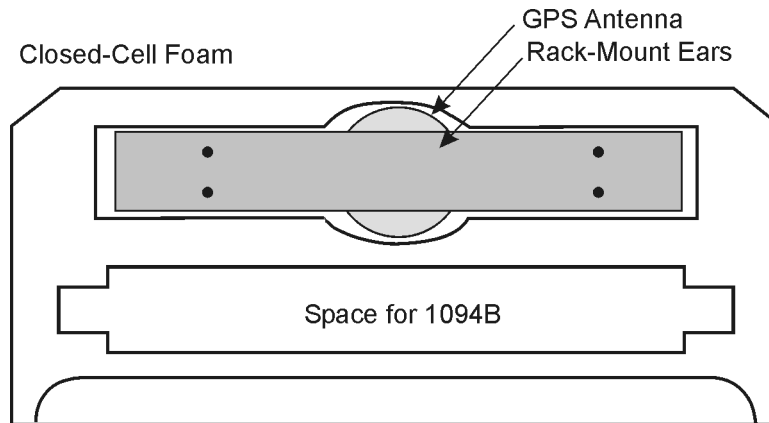

Figure 1.1: Packaging of Accessories

Antenna cable, clock and setup guide are located between the two pieces of closed-cell foam. The rack-mount ears and antenna are embedded in the packing foam side labeled **ADDITIONAL PARTS INSIDE**.

1.4 Attaching Rack-Mount Ears to Clock

Each Model 1094B comes with two rack-mount ears suitable for mounting in a 19-inch system rack. These ears have four mounting holes, two of which are used to attach them to the sides of the clock. Since it is required to remove the M25 x 10 screws which attach the cover to the chassis, it may be good to attach the ears after first making any jumper configuration inside the clock. You will want to return to this section after making these changes.

1.4.1 Mounting Instructions

1. Using a Torx T25 driver or large slot screwdriver, remove the four M25 screws attaching the clock cover to the chassis. Use either a Torx T25 driver, or a large slot screwdriver.
2. With the ear facing out from the front panel, match the lower set of holes of the rack-mount ear to the cover/chassis and remount the M25 screws.
3. Repeat this procedure with the other side of the chassis and other rack-mount ear.

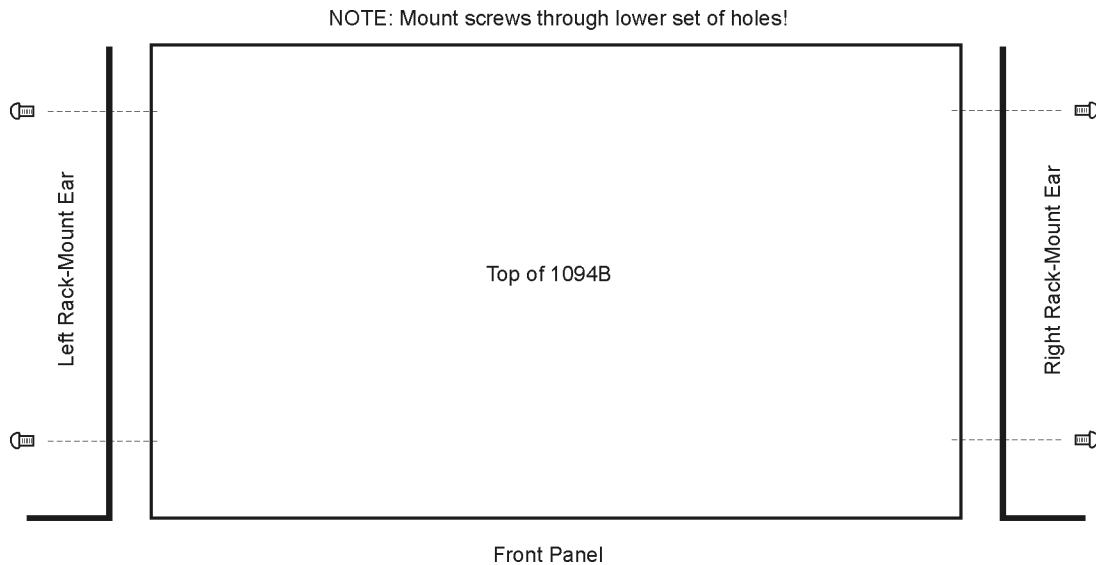

Figure 1.2: Attaching Rack-Mount Ears

NOTE: Before installing the rack-mount ears, you might want to determine if you need to set any internal jumpers. To install the rack-mount ears requires removal of the top cover, which would be a good time to make any changes to jumper settings. For detailed information on setting internal jumpers, see Chapter 5.

1.5 Mounting Antenna and Antenna Cable

For detailed information on mounting the GPS antenna and antenna cable(s), see Chapter 4.

Chapter 2

Front and Rear Panels

2.1 Introduction

Chapter 2 introduces and identifies the connectors, controls, and displays found on the front and rear panels of the 1094B. Take care to review all of these items prior to connecting cables and configuring the Model 1094B.

2.2 Front Panel Controls and Indicators

The Model 1094B front panel has a two-line by 20-character, backlit, supertwist Liquid Crystal Display (LCD), four annunciator LED's, an eight-button keypad and ON-OFF power switch. The upper row of keys are for viewing clock information and the lower row of keys are for configuring the instrument. Figure 2.1 illustrates indicators and controls used to determine the status and configure the operation of the 1094B.

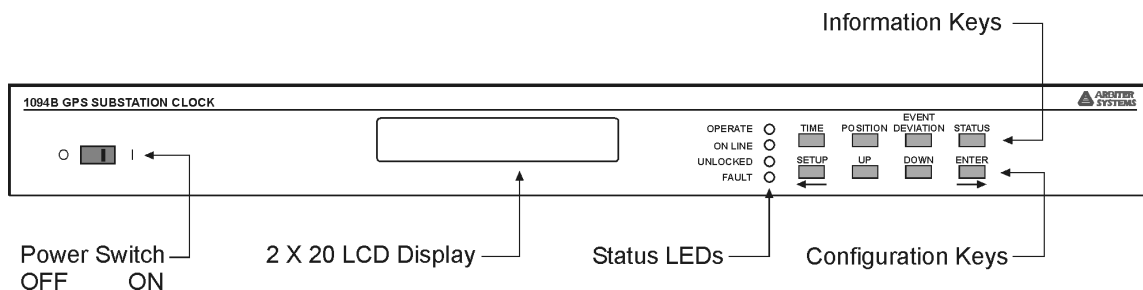

Figure 2.1: Front Panel Description

Definitions for the annunciator LEDs are found in Table 2.1, and definitions for keys in Table 2.3. Each of upper row of keys allow you to view clock information, such as Time and Date, Geographical Position and Instrument Status. Each of the lower row of keys have primary and secondary functions for configuring operation. To configure, see Chapter 7, The Setup Menus.

2.2.1 Annunciator LED Definitions

Annunciator LED	Color	Purpose
Operate	Green	Clock Operating
Stabilized	Flashing Green	Clock Time stabilizing
	Steady Green	Clock Time accurate
Unlocked	Red	Out-of-Lock when ON
Fault	Red	Internal fault when ON

Table 2.1: Annunciator LED Definitions

The four LED's provide information about the operational status of the instrument. The Operate and Stabilized LED's are green and the Out-of-Lock and Fault LED's are red. For normal operation, with the clock locked and accurate, both green LED's should be ON and both red LED's should be OFF. The following definitions apply to these indicators:

- **OPERATE:** Indicates that power is being supplied to the clock.
- **STABILIZED:** Flashes (ON-OFF, 1 second intervals) when clock time is stabilizing with GPS. Is steady when the clock time is accurate.
- **OUT OF LOCK:** Illuminates when the clock has not yet synchronized, or has lost synchronization, with the GPS.
- **FAULT:** Illuminates when an internal fault occurs. Faults are listed below.

Fault Indication	Definition
Out-of-Lock	GPS Receiver is not receiving satellite signals
Receiver Failure	Clock not communicating with GPS receiver
Antenna Short	Voltage (5 V) at antenna connector low (shorted)
Antenna Open	Open circuit condition at antenna (disconnected?)

Table 2.2: Fault Indications and Definitions

2.2.2 LCD Display

The Model 1094B contains a back-lit, liquid crystal display, which provides a 20-character by 2-line readout that displays instrument time and date, geographical position, event data and status. Using the lower set of keys, the readout is also used to display the current configuration of operation parameters.

2.2.3 Command Key Definitions

Control the various functions and configuration of operational parameters using the eight pushbutton keys on the front panel. Use the 1094 Utility, or the RS-232 command "m,nFP," to control the operation of the keypad and display; this includes locking and unlocking the lower row of keys and turning the backlight on or off. For a detailed description of the "m,nFP" RS-232 command, see Section 10.3.8. All front-panel keys are described below.

Key	Function	Alternate Function
TIME	time and date	NA
POSITION	view latitude, longitude and elevation	NA
EVENT or DEVIATION	view Event or Deviation	NA
STATUS	view Clock and Receiver Status	NA
SETUP	enter setup mode	move cursor left in data entry mode
UP	select upper value	increase numerical value
DOWN	select lower value	decrease numerical value
ENTER	install selected value	move cursor right in data entry mode

Table 2.3: Command Key Definitions

Time Key

Sets the display to the Time Display Mode. There are four modes of the time display available and repeated pressing of this key will cause the display to scroll through all four modes continuously. Changing the time display has no effect on the time data, which is output from rear-panel timing outputs.

Position Key

Cycles the display through the longitude, latitude, and elevation data readouts of the antenna location according to the most recent position fix.

Event/Deviation Key

Select review of Event or Deviation Data for the Event/Deviation input. For additional details on events and deviation, see the Index under “event inputs.”

Status Key

Press the Status key to toggle between four status display modes: Clock, Receiver, Tracking and EEPROM, and the display of GPS satellite acquisition and synchronization. For more detail on these readouts, see Chapter 6, Clock Startup and Utility Software.

Setup Key

Invokes a series of menus used to adjust configurable parameters within the clock. In numeric data entry mode, moves the cursor to the left.

Up Key

Used in conjunction with the Setup menus to adjust numerical values upward, or to scroll upward through the available menu choices. Also assists in navigating through main Setup menus in normal order.

Down Key

Used in conjunction with the Setup menus to adjust numerical values downward, or to scroll downward through available menu choices. Also assists in navigating through main Setup menus in reverse.

Enter Key

Used for confirming changes made within Setup menus. Generally, pressing Enter also advances to the next parameter, or progresses to the next menu level. In numeric data entry mode, moves the cursor to the right.

2.3 Rear Panel Identification and Connectors

This section contains information to assist you in identifying where to connect inlet power, the GPS antenna cable and all of the input and output cables on the Model 1094B.

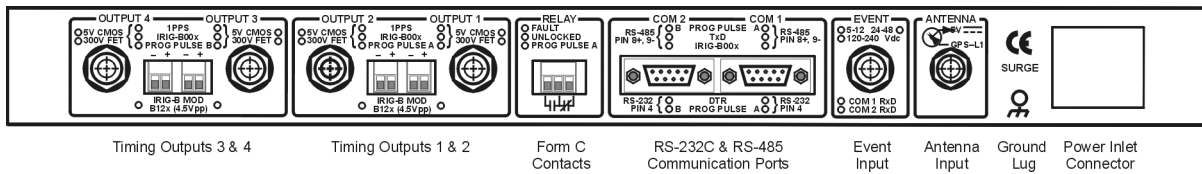

Figure 2.2: Rear Panel Description

2.3.1 Power Inlet

To cover a wide range of inlet power sources, the Model 1094B has three optional power supplies. Please examine the paperwork you received with the Model 1094B, to make sure you have correctly identified the inlet connection. Supply types are listed below:

Option 07 (RoHS)

IEC-320 supply with a range of 110 Vdc to 350 Vdc and 85 Vac to 264 Vac, 47 Hz to 440 Hz.

Figure 2.3: Option 07 Power Supply Inlet Connector (RoHS)

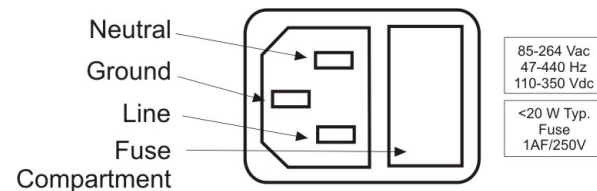

Option 08 (RoHS)

10 Vdc to 60 Vdc ONLY, Terminal Power Strip with Surge Withstand Protect Circuitry (SWC).

Figure 2.4: Option 08 Power Supply Inlet Connector (RoHS)

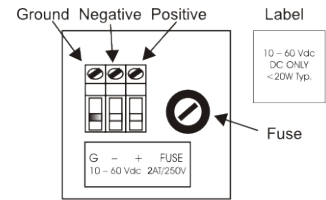

Option 10 (RoHS)

110 Vdc to 350 Vdc and 85 Vac to 264 Vac, 47 Hz to 440 Hz, Terminal Power Strip with Surge Withstand Protect Circuitry (SWC)

Figure 2.5: Option 10 Power Supply Inlet Connector (RoHS)

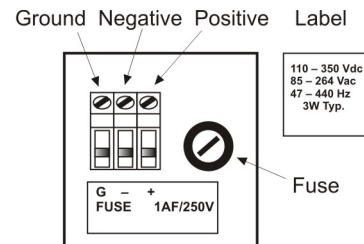

2.3.2 Antenna Input

The Model 1094B provides a Type F, GPS antenna input connector not only as the connection point for GPS signal, but also supplies 5 volts to energize the antenna. It is equipped with a threaded, Type F female connector.

Figure 2.6 illustrates a Type F female, antenna connector. For further information on antennas and antenna cabling, see Chapter 4, GPS Antenna and Cable Information.

Figure 2.6: GPS Antenna Connector

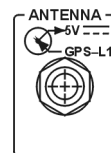

2.3.3 Event Input

For timing external events based on the GPS-synchronized time, use the Event Input function. One dedicated event input port is available and equipped with an isolated, BNC female connector. External events may also be timed from either of the two standard communication ports.

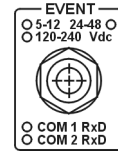

Figure 2.7: Event Input Connector

2.3.4 RS-232 and RS-485 Communication Ports

The Model 1094B has two identical communication ports with RS-232 and RS-485 supported. The RS-232 port does not use flow control, and RS-485 is transmit only (uses Transmit A and Transmit B; there is *NO ReceiveA or ReceiveB*). Generally, for RS-232 communications, you will only need pins 2, 3 and 5 using a null-modem cable. For more information, see Chapter 10, Serial Communications and Commands.

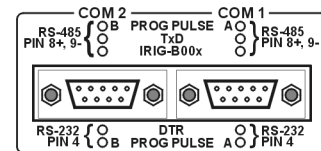

Figure 2.8: Communication Port Connectors

2.3.5 Form C Relay Contacts

The Model 1094B has one set of Form C relay contacts that have three contact points: Normally Open (NO), Normally Closed (NC) and Common (COM) as illustrated in Figure 2.9. Contact functions include Fault, Out of Lock or Programmable Pulse A. Fault, or Out-of Lock, relay functions are defined when relay is de-energized (e.g. clock powered off). To configure the contact function, see Section 5.3. For information on how to connect to relay contacts, see Section 9.5; for specifications, see Section A.4.

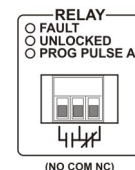

Figure 2.9: Relay Contact Connectors

Two examples are cited to clarify the relay operation. The left pin in Figure 2.9 is the Normally Open (NO) contact to the Common (COM) center pin. The right pin is the Normally Closed (NC) contact to the Common (COM) center pin.

1. Fault, or Power Off: COM to NC shorted, COM to NO open
2. No Fault and Power ON: COM to NC open, COM to NO shorted

2.3.6 Timing Outputs

The Model 1094B has four identical timing outputs, with both 5mm terminals for twisted pair wire and BNC female connectors for coax, to suit a variety of cabling requirements. Viewed from the rear panel, they are labeled Output 1, Output 2, Output 3 and Output 4 from right to left. Both connectors of one output channel may be used simultaneously from the same output channel, being wired in parallel. Single connectors may also be “Tee’ed” for parallel-connected loads. For more information concerning how to connect any timing output for distribution to protective relays, see Chapter 8, Timing, IRIG-B and Pulses.

Figure 2.10: Timing Connectors, IRIG-B and Pulse

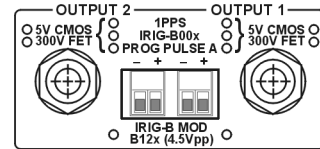

Chapter 3

Connecting Inlet Power

To cover a wide range of inlet power sources, the 1094B can be ordered with any one of three different power inlet modules. Each of the power inlet module connectors is illustrated here and also in Chapter 2. Take time to examine the power inlet module connection on your clock to verify that it is correct according to your order. Also, make sure to check the inlet module for polarity and voltage marking before connecting power to the clock.

3.1 Option 07, IEC-320 Power Inlet Module (RoHS)

The Option 07, IEC-320 power inlet module has a “computer type” power connector with power cord for the required country code. Voltage and system frequency are given below with an outline of the connector.

Input Ratings: 85 Vac to 264 Vac, 47 Hz to 440 Hz, or 110 Vdc to 350 Vdc

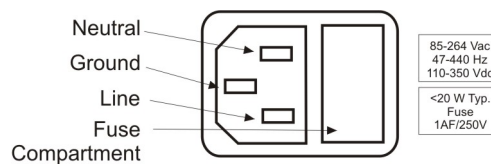

Figure 3.1: Option 07 Power Supply Inlet Description

3.1.1 Cordsets and Plug Styles for Option 07

Make sure that the cordset matches the wall connector for your country. The following are available IEC-320 mating cordset plug style and specifications:

No.	Country	Specification	Rating
P01	Continental Europe	CEE 7/7	220V
P02	Australia, NZ, PRC	AS3112-1981	240V
P03	U.K.	BS 1363	240V
P04	Denmark	Afsnit 107-2-01	240V
P05	India	BS 546	220V
P06	Israel	SI 32	220V
P07	Italy	CEI 23-16/VII 1971	220V
P08	Switzerland	SEV 1011.1959	220V
P09	North America and ROC	NEMA 5-15P CSA C22.2#42	120V
P10	Japan	JIS8303	120V

Table 3.1: Available IEC-320 Cordsets by Country

3.1.2 Option 07, Connecting Power to the 1094B

Connect the IEC-320 plug to the IEC-320 connector on the 1094B, and then connect the wall plug into the wall socket.

3.2 Option 08, 10 Vdc to 60 Vdc Power Inlet Module (RoHS)

This option replaces the standard power supply with one accepting 10 Vdc to 60 Vdc (only), < 20 VA typical. Replaces the standard IEC-320 inlet with a 3-pole terminal strip. Provides input surge protection (SWC) for compliance with ANSI C37.90-1 and IEC 801-4. Option 08 operates from common low-voltage battery systems, including 12 Vdc, 24 Vdc and 48 Vdc.

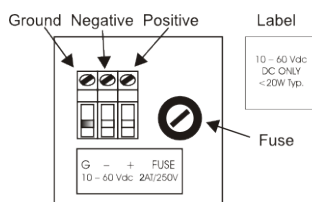

Figure 3.2: Option 08 Power Supply Inlet Description

3.2.1 Option 08, Connecting Inlet Power

When wiring station batteries to this power supply, make sure to first connect an earth ground wire to the terminal strip connector labeled “G” (for ground). Positive and Negative terminals are marked on a label as “+” and “-”. After connecting a ground wire, connect the positive and negative leads from the station batteries to the corresponding Option 08 terminals.

3.3 Option 10, 110 Vdc to 350 Vdc Terminal Power Strip, Surge Withstand (RoHS)

This option replaces the standard IEC-320 inlet with a 3-pole terminal strip and provides inlet surge protection for compliance with ANSI C37.90-1 and IEC 801-4. Input voltages are: 85 Vac to 264 Vac, 47 Hz to 440 Hz, or 110 Vdc to 350 Vdc, < 20 VA typical.

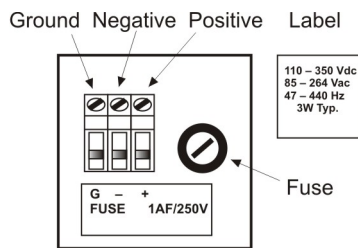

Figure 3.3: Option 10 Power Supply Inlet Description

3.3.1 Option 10, Connecting Inlet Power

When wiring this power supply, make sure to first connect an earth ground wire to the terminal strip connector labeled “G” (for ground). Positive and negative terminals are marked on the terminals as “+” and “-”. After connecting a ground wire, connect the positive and negative leads to the clock power inlet terminals. Lastly, connect the power inlet leads to the station batteries. When using with AC inlet supplies, Positive is the same as Line and Negative is the same as Neutral.

3.4 Fuse Locations and Types

Use the fusing table below for identifying the correct fuse for your option power supply.

PS Option	Arbiter P/N	Fuse ID	Size, mm
07	FU0001816	F1AL250V	5 x 20
08	FU0001419	T2AL250V	5 x 20
10	FU0001816	F1AL250V	5 x 20

Table 3.2: Fuse Chart

3.4.1 Replacing Fuses

Option 07 (IEC-320 power inlet connector): includes a 1-A, 250-V fast acting fuse. The fuse is contained in a small compartment with a snap-fit latch, which also has a compartment for a spare fuse. Check Figure 3.1 for a fuse location diagram.

The fuse compartment is located directly adjacent to the input connector socket, and can be opened by pulling both sides directly out away from the chassis, or by gently prying with a small flag-blade screwdriver. To replace the fuse, first disconnect the line cord from the power source and then remove the cord from the rear-panel IEC connector. The in-circuit fuse is the innermost one; inspect it to determine if it is open. As required, replace with fuse in the outer compartment, and replace the spent fuse.

Option 08 or Option 10 (terminal strip connector): inlet power modules include separate, threaded fuse holder adjacent to the terminal power strip – see Figures 3.2 and 3.3. See Table 3.2 for the correct fuse configured for your option.

To check or replace the fuse, first disconnect inlet power from the clock. Using a small flat-blade screwdriver, turn the fuse cover counter-clockwise (CCW) and it should pop outward. Replace fuse only with another of the same type and rating.

Chapter 4

GPS Antenna and Cable Information

The Model 1094B comes complete with the necessary hardware to be able to receive GPS signals: an RG-6 cable assembly and a GPS antenna. Cable assemblies are fitted with male F connectors and connect between the antenna and the rear panel of the clock. This section should help you with installing the GPS antenna and antenna cable(s) to the 1094B. It should also be a source of information should you need to trouble shoot the antenna cable system.

4.1 GPS Antenna Installation

To properly receive GPS signals, the GPS antenna needs to be mounted clear of buildings and surrounding elements that would block the GPS signals being transmitted by the satellites. For complete coverage, the antenna needs to have a clear view of the sky from 10 degrees above the horizon to directly overhead for all points of the compass. Minimal installations, where the antenna is mounted in a less favorable location, may work however reception may be somewhat limited during certain hours of the day. This is because the GPS satellites are continually moving across the sky, into and out of view of the antenna.

4.1.1 Mounting the Antenna

The standard antenna is designed for pole mounting on a 26 mm pole (1.05 in OD or 3/4 in ID pipe), with either a standard 1 in – 14 (approximately M25.4 x 1.81) marine-mount thread or a 3/4 in NPT pipe thread. The Type F connector on the inside of the antenna is protected from direct exposure to the elements when the antenna is mounted in this way. This will extend the operational life of the antenna-to-cable interface.

To mount the antenna, you will need a piece of 3/4 in pipe nipple that can be attached to a solid fixture. The piece of pipe nipple should be threaded up into the antenna receptacle after connecting the antenna cable to the Type F cable adapter. Arbiter Systems sells an antenna mounting kit (P/N AS0044600) that simplifies installation for a variety of locations. Figures 4.1, 4.2 and 4.3 illustrate several components of the AS0044600 mounting kit for a suggested mounting method.

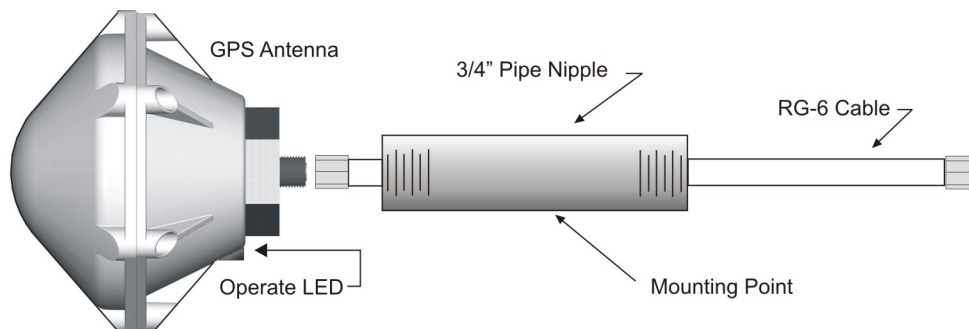

Figure 4.1: Antenna Assembly for Mounting

Antenna mounting procedure:

1. Thread the RG-6 antenna cable through the pipe
2. Tighten the Type F male connector to the antenna connector
3. Thread the pipe into the antenna
4. Mount the pipe and antenna/cable assembly to a stationary point

4.1.2 Optional Antenna Mounting Kit, P/N AS0044600

The AS0044600 Antenna Mounting Kit, specifically for use with antennas shipped with Arbiter Systems GPS-controlled clocks, includes several items including the mounting bracket. The hardware included with the bracket allows installation of the antenna on a mast or pipe up to about 2 in in diameter, and a different clamp may be substituted for use with a larger diameter pipe. Also, the bracket can be mounted to a wall, a roof, or any other flat surface.

For complete details on this product request installation instructions for Arbiter Systems GPS Antenna Mounting Kit found on document number PD0024700. All metallic hardware is stainless steel.

Qty	Description	ASI P/N
1	Mounting bracket, stainless steel	HD0052700
1	U-bolt, 1-1/8 in, SS, mounting plate, 2 hex nuts	HP0026700
1	Threaded pipe, 3/4 in × 4 in PVC, schedule 80	HP0014804
1	Hose clamp, 5/8 in x 1-1/4 in to 2-5/8 in, worm drive, stainless steel	HP0014900

Table 4.1: Antenna Mounting Kit Parts List

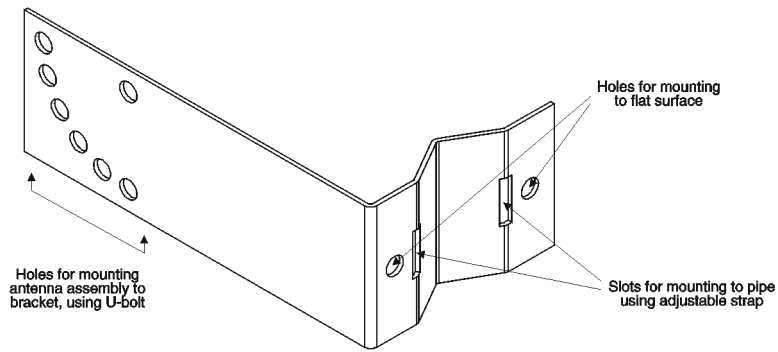

Figure 4.2: Antenna Mounting Bracket

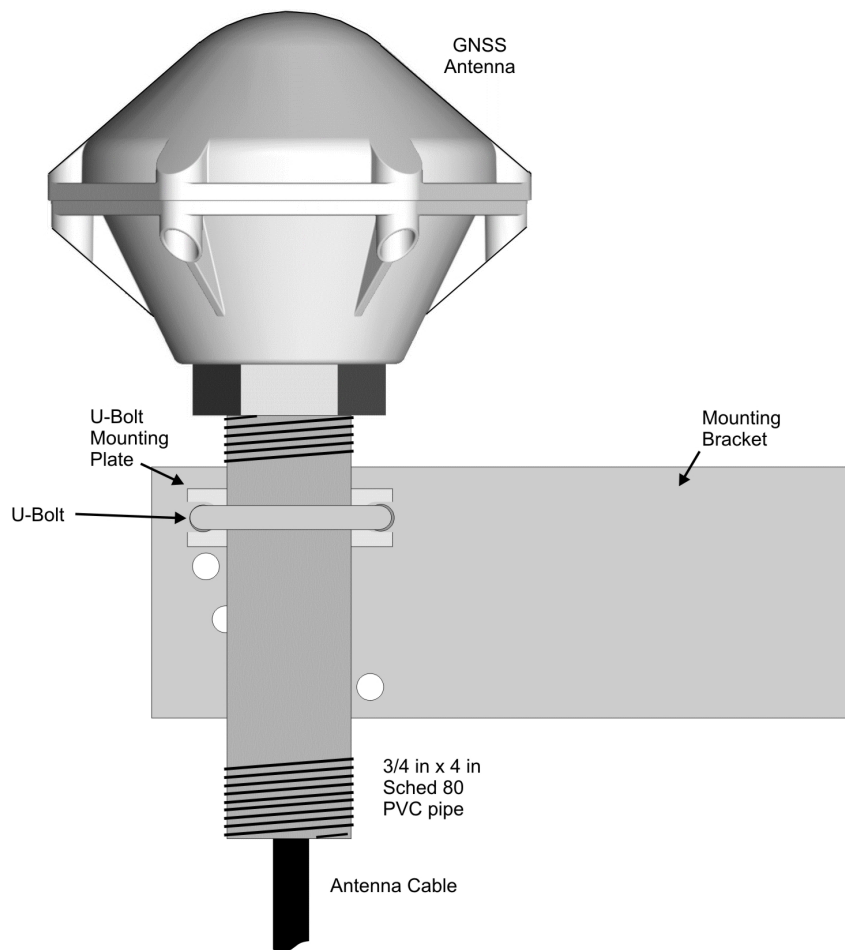

Figure 4.3: Antenna Mounting with AS0044600

4.2 Verifying Antenna and Cable Operation

Proper antenna and cable operation may easily be verified after installation. *If the FAULT LED is ON, indicating that a fault exists, press the STATUS key for a fault message (see Table 2.2).* Also, the antenna itself has a two-color Operate LED located at the base of the antenna to signal operating status. GREEN indicates proper operation (i.e. it is getting the correct voltage); AMBER indicates improper operation (i.e. the voltage is low).

4.2.1 GPS Signal Strength

Use the SR command through a terminal program to view the receiver status. SR returns latest receiver status, which includes the GPS signal strength. See Receiver Status under Section 10.3.6.

4.2.2 Checking the Antenna Voltage

A more comprehensive antenna test is to apply 5 Vdc to the antenna, through F connector (center positive). The Arbiter antenna should draw 30 mA. The GPS clock provides a +5 Vdc signal at 30 mA nominal, which is carried through the antenna cable to the GPS antenna. Without the signal, the antenna and the GPS clock will not synchronize with the Global Positioning System, and can generate an out-of-lock alarm if the Out-of-Lock feature is enabled.

4.2.3 Power Supply Check

The Antenna Voltage test (above) actually tests the main power supply voltage. The clock should provide between 4.9 Vdc to 5.1 Vdc to the antenna.

4.2.4 Checking the Antenna Resistance

Checking the internal resistance of the Arbiter GPS antenna is not as useful as checking antenna current mentioned above. Antenna resistance measures several megohms with meter probes at one polarity and less so if you change the meter probe polarity.

4.3 GPS Surge Arrester

Figure 4.4 illustrates the GPS surge arrester kit, which is mounted in line with the antenna cable. The surge suppressor has two female F connectors, which are bidirectional, and two ground lugs with hardware for connecting to a solid ground.



Figure 4.4: GPS Surge Arrester

4.3.1 Using the GPS Surge Arrester

Before installation, review the documentation on this device found in Appendix B. The surge arrester is weatherproof except for the F connectors, which may be sealed with rubber port seals or GE Silicone II compound.

4.4 Technical Details on GPS, Antennas and Cables

4.4.1 Antenna Cable

Length and Loss Considerations

Standard Antenna Cable

The standard antenna cable assembly included with the clock is constructed using a 15-meter (50-foot) length of RG-6 type low-loss coaxial cable, terminated with male Type F connectors. Optional lengths of RG-6 coax are separately available for longer runs; see Table 4.2, Cable Data and Accessory Information.

Effects of Cable Parameters

To receive GPS signals and properly operate the clock, the type and length of the cable are important. Due to their effect on specific parameters described in the following paragraphs, any changes to the length and/or type of antenna cable should be made carefully. Damaged cables may also affect performance.

Cable Delay

The velocity factor and the physical length of the cable determine cable delay. During the initial factory calibration of the clock, a value for cable delay (based upon the length and type of cable supplied) is entered into the clock memory. Firmware uses this figure to counteract the effect that the delay has upon GPS timing accuracy. The value entered for a standard 15-meter cable is 60 nanoseconds. For other cable options, the delay is tabulated in Table 4.2 below. The formula for calculating cable delay is:

$$(4.1) \quad T = \lambda \frac{1}{CKv} + 1ns$$

Where:

- T = Cable delay, in nanoseconds;
- λ = Cable length, in meters;
- C = Speed of light (3×10^8 meters per second);
- Kv = Nominal velocity of propagation (0.85).

One nanosecond is added to the calculated value to account for the length and velocity factor of the short connecting cable inside of the clock.

Attenuation

Attenuation depends upon the cable length, and the loss per unit length. The total attenuation must be limited to 21 dB (maximum) at the GPS L1 frequency of 1575.42 MHz. Loss up to 42 dB can be accommodated with the separately available 21 dB in-line preamplifier.

DC Resistance

The cross-sectional area and length of the conductors in the cable determine the dc resistance. Since power to the RF preamplifier in the antenna is supplied via the antenna cable, excessive dc resistance will degrade performance.

Because of the above factors, changes to the length and/or type of antenna cable should be made carefully. Damaged cables may also affect performance.

Available Antenna Cables and Accessories for Longer Runs

Arbiter Systems offers longer antenna cables for use with all models of clocks when the standard 15 m (50 ft) cable is inadequate. For RG-6 cable runs greater than 250 feet, up to 500 feet, Arbiter offers a 21 dB in-line amplifier. A larger RG-11 style cable is available that can be used for runs to 120 m (400 ft) without the in-line preamplifier, or 240 m (800 ft) with the in-line preamplifier.

P/N	Description	Delay	Signal Level
CA0021315	15 m (50 ft) cable, RG-6	60 ns	-5 dB
CA0021330	30 m (100 ft) cable, RG-6	119 ns	-9 dB
CA0021345	45 m (150 ft) cable, RG-6	177 ns	-13 dB
CA0021360	60 m (200 ft) cable, RG-6	236 ns	-17 dB
CA0021375	75 m (250 ft) cable, RG-6	295 ns	-21 dB
WC0004900	300 m (1000 ft) roll RG-11	3.92 ns/m	-17.5 dB/100m
AS0044800	Kit, crimp tool and 25 connectors, RG-11	N/A	N/A
AS0044700	21 dB in-line amplifier	1 ns	+21 dB

Table 4.2: GPS Cable Data and Accessory Information

Physical Protection

When routing the antenna cable, protect it from physical damage, which may result from closing doors, falling objects, foot traffic, etc. Also, when routing around corners, allow for sufficient bend radius to prevent kinks. Extra length should be allowed at both ends of the cable to prevent tension on the connectors, which could cause damage or failure. Extra length is useful as a service loop, in the event that a connector needs replacement.

Do not stretch the cable mid-air over any appreciable distance without support. Cable degradation or failure could result. Always leave a drip loop wherever the cable enters a structure, to prevent water from entering the structure via the cable jacket. The maximum temperature rating for the type of cable provided with the clock is 75 °C (167 °F). Exercise care when routing the cable near sources of heat to avoid cable damage.

Adjacent Signals

Although the standard RG-6 style cable is triple-shielded and has excellent shielding properties, be cautious when routing near high power RF sources or alongside cables carrying high power RF, such as transmitter cables. In these applications, consider using RG-11 style cable. Its quad-shielded design provides even more isolation.

Antenna Power

The RF preamplifier within the antenna requires 5 Vdc at 30 mA nominal for operation. A power supply within the clock generates this voltage, which is applied to the antenna via the two conductors of the coaxial antenna cable. Avoid shorting the center conductor to the shield of the coaxial cable as it may damage the preamplifier. Conversely, a high-resistance connection or open circuit would deprive the preamplifier of power. Either a short- or open-circuit condition in the antenna cable will render the clock inoperable.

Prior to initial operation or if problems are suspected, perform the suggested checks or tests covered in Section 4.2.

Connection to Antenna

The male Type F connector on one end of the antenna cable mates with the female Type F connector on the antenna. Avoid placing mechanical stress on the cable attachment to the antenna.

Connection to Clock

The male Type F connector on the opposite end of the antenna cable connects to the female Type F connector on the rear panel of the Substation Clock.

User-Supplied Antenna Cables

Any RF cable meeting the requirements described above for loss (< 21 dB at 1575 MHz) and dc resistance ($< 15\ \Omega$ total loop resistance) may be used with the clock. However, prior to using a non-standard antenna cable, verify proper installation by performing the power supply and antenna verification covered in Section 4.2.

For additional technical details concerning the GPS, antennas and antenna cabling see Appendix A, Technical Specifications and Operating Parameters.

Chapter 5

Setting Internal Jumpers

5.1 Introduction

This section should assist you with identifying and configuring the internal jumpers in the Model 1094B so that all the input and output signals are routed correctly. **NOTE:** *Values in tables marked with an “*” show default positions.*

The next step after correctly setting the necessary jumpers is to configure the clock settings. To configure using the front panel keys, go to Chapter 7, The Setup Menus. The Setup menus provide details on how to configure these signals from the front panel keys. To configure using the 1094 Utility software, go to Chapter 6, Clock Startup and Utility Software. For additional technical details about timing signals, please see Chapter 8, Timing, IRIG-B, and Pulses.

5.1.1 Jumper Locations

Figure 5.1 outlines the main board in the Model 1094B depicting the approximate locations of the various jumpers. Use this drawing to assist you with locating the jumpers you want to configure. Jumpers are noted on the main board with a “JMP” prefix before the numbered location. For example, jumper 1 would have a label of JMP1 on the main board, however Figure 5.1 only references this jumper as “1.” Also, note that JMP1 is not used, and should have been hard wired or soldered in its intended position at the factory.

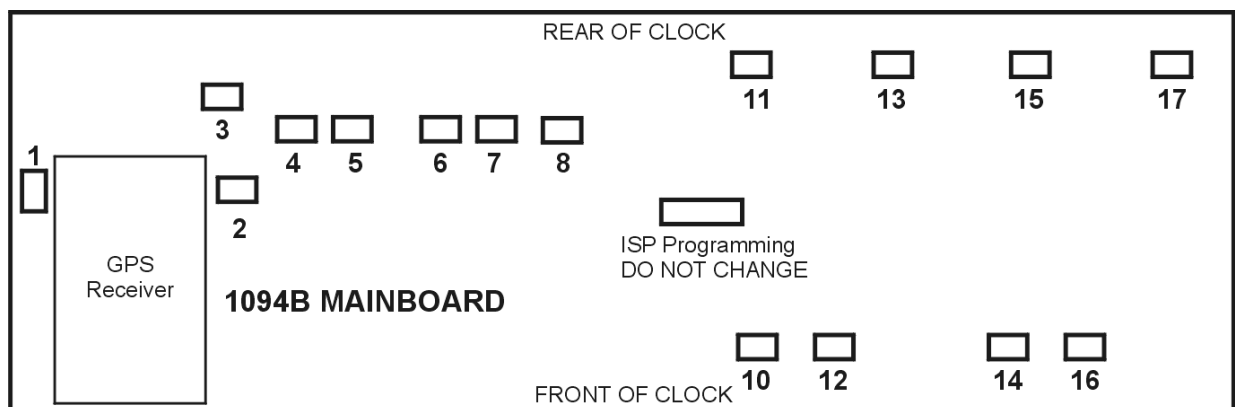

Figure 5.1: Mainboard Jumper Locations

5.1.2 List of Default Jumper Positions and Functions

Jumper	Function	Default Setting
JMP1	Antenna Preamp	Fixed (do not change)
JMP2	Event Input Connector	C - Event Panel
JMP3	Event Input Voltage	A, 5 to 12 Vdc
JMP4	Comm Port 1	A, Txd - ch
JMP5	Comm Port 1	B, DTR
JMP6	Comm Port 2	A, Txd - ch
JMP7	Comm Port 2	B, DTR
JMP8	Relay Mode (Form C Contacts)	A, Out Of Lock
JMP10	Timing Output 1	A, IRIG-B, unmodulated
JMP11	Timing Output 1	C, CMOS - 5 Vdc
JMP12	Timing Output 2	A, IRIG-B, unmodulated
JMP13	Timing Output 2	C, CMOS - 5 Vdc
JMP14	Timing Output 3	A, IRIG-B, unmodulated
JMP15	Timing Output 3	C, CMOS - 5 Vdc
JMP16	Timing Output 4	A, IRIG-B, unmodulated
JMP17	Timing Output 4	C, CMOS - 5 Vdc

Table 5.1: Default Mainboard Jumper Settings

NOTE: Jumpers in the following tables are grouped according to main functions and not necessarily in numerical order.

NOTE: Values in tables marked with a “*” show the default positions.

5.2 Configuring Output Jumpers

The Model 1094B has four multifunction timing outputs that may be configured independently. To configure any of the output jumpers, follow the steps enumerated below. Table 5.2 organizes the four outputs in one table, since they are all configured in the same manner.

Signal	Output 1	Output 2	Output 3	Output 4
IRIG-B00X	JMP10 = A*	JMP12 = A*	JMP14 = A*	JMP16 = A*
1 PPS	JMP10 = B	JMP12 = B	JMP14 = B	JMP16 = B
Prog Pulse	JMP10 = C	JMP12 = C	JMP14 = C	JMP16 = C
	P-P A	P-P A	P-P B	P-P B
300-V FET	JMP11 = A	JMP13 = A	JMP15 = A	JMP17 = A
IRIG-B12X	JMP11 = B	JMP13 = B	JMP15 = B	JMP17 = B
CMOS, 5 V	JMP11 = C*	JMP13 = C*	JMP15 = C*	JMP17 = C*
* = default setting				

Table 5.2: Timing Output Jumper Selection

NOTE: Values for ‘X’ in IRIG-B00X (unmodulated) and IRIG-B12X (modulated) are 0 if the IEEE 1344 is ON, or 3 if IEEE 1344 is OFF. Configure the IEEE 1344 function in the IRIG-B

setup menus; see Section 7.9.13 and 7.10 for details on *setting the IEEE 1344 Extension*. For a brief definition of the IEEE 1344 Extension, see Chapter 8.

5.2.1 Configuration Notes

1. To set Output 1 as unmodulated IRIG-B (5 VCMOS, demodulated, or level shift) set jumper JMP10 = A and jumper JMP11 = C. Similarly, to set Output 2 for unmodulated IRIG-B, set JMP12 = A and JMP13 = C.
2. To set any output as modulated IRIG-B, set only one jumper. For example, to set Output 2 as modulated IRIG-B, set jumper JMP13 = B. Jumper JMP12 is not required.
3. To set any output as programmable pulse, use two jumpers. For example, to set Output 3 to programmable pulse and 300 V FET, set jumper JMP14 = C and JMP15 = A. Note that Programmable Pulse A configures Outputs 1 and/or 2, and Programmable Pulse B configures Outputs 3 and/or 4.
4. Remember to configure any IRIG-B timing output from the front panel for the UTC or Local time zone and whether you want IEEE 1344 ON or OFF. See Figure 7.20 for setup information.

5.3 Configuring Relay Mode Jumpers

The Model 1094B has one set of Form C relay contacts that may be configured to alarm (or trip) for a Fault, for an Out-Of-Lock condition, or according to the Programmable Pulse A function. By default, the relay is connected to indicate an unlocked condition. When the 1094B is unlocked (i.e. not tracking GPS satellites) the red, UNLOCKED LED, should also be lit to indicate an unlocked condition. See Table 5.3.

Function	JMP8, Jumper Position
Out of Lock	A*
Fault	B
Prog. Pulse A	C

Table 5.3: Relay Jumper Positions

NOTE: If configuring relay contacts for programmable pulse, use only Programmable Pulse A Mode.

5.3.1 Relay Contact Specifications

Life expectancy (electrical) is 100,000 operations; resistive load test at 250 VAC, 8 A, room temperature with diode. Continuous monitoring must be performed to detect contact sticking and short circuit. Dielectric strength measured at 500 V for 1 minute with same polarity.

5.4 Configuring Communication Port Jumpers

The Model 1094B has two communication ports (COM1 and COM2) that can provide both RS-232C and RS-485 levels. Alternately, these ports may be configured to provide a programmable

pulse output and IRIG-B at RS-485 levels. See Table 5.4 for details on jumper positions. See Table 10.1 for COM1 and COM2 pin definitions.

Driver	Output Signal	COM1	COM2
RS-232	Prog Pulse A	JMP5=A	JMP7=A
"	DTR*	JMP5=B	JMP7=B
RS-485	TXD-Ch*	JMP4=A	JMP6=A
"	Prog Pulse B	JMP4=B	JMP6=B
"	IRIG-B	JMP4=C	JMP6=C

Table 5.4: Communication Port Jumper Selection

NOTE: COM1 can serve as an alternate port for Programmable Pulse A, and COM2 can serve as an alternate port for Programmable Pulse B.

1. For standard RS-232 communications on COM1 or COM2, move jumpers JMP5 or JMP7 to position B.
2. To transmit a programmable pulse from COM ports at RS-232 levels, move jumper JMP5 or JMP7 to position A.
3. To transmit a programmable pulse from COM ports as RS-485, move jumper JMP4 or JMP6 to position B.
4. To transmit IRIG-B data from either COM1 or COM2, move jumper JMP4 or JMP6 to position C. To set up IRIG-B timing, use "SET IRIG MAIN?" found in Section 7.10.

5.5 Configuring Event Input Jumpers

The Model 1094B has one Event Input function that has two modes: (1) Event Capture, and (2) 1-PPS Deviation measurement. Events may be recorded from two connection points: (1) the dedicated event input connector, and (2) either COM1 or COM2. Using the dedicated Event Panel connector, you can set the event input voltage level to one of three ranges: 5 Vdc to 12 Vdc, 24 Vdc to 48 Vdc, or 120 Vdc to 240 Vdc. Alternately, you may capture RS-232 signals as an event at either COM1 or COM2 (pin 2). Apply only RS-232 signal levels to COM1 or COM2. See Tables 5.5 and 5.6.

Input Connector	Input Signal	Jumper & Position
Event	5 Vdc to 12 Vdc	JMP3 = A*
Event	24 Vdc to 48 Vdc	JMP3 = B
Event	120 Vdc to 240 Vdc	JMP3 = C

Table 5.5: Event Input Voltage Selection

5.5.1 Selecting the Event Input Channel and Voltage

1. Select the input channel as the designated BNC Event Input (default), COM1 or COM2 (pin 2); choose jumper position A for COM1, B for COM2, or C for the BNC Event connector (default).

Input Connector	Jumper & Position
COM1	JMP2 = A
COM2	JMP2 = B
Event	JMP2 = C*

Table 5.6: Event Input Connector Selection

2. To select a voltage level, move jumper JMP3 to A for 5 Vdc to 12 Vdc (default), to B for 24 Vdc to 48 Vdc, or to C 120 Vdc to 240 Vdc.

5.5.2 Configuring the Event/1-PPS Function

Configure the Event Input feature by using the setup menus, through the front-panel keypad, or remotely through COM1 or COM2. To use the setup menus, see Section 7.12. To use either COM1 or COM2, see Section 7.12 using the 1094 Utility, or Section 10.3.5, Event Mode Commands using a terminal program.

Chapter 6

Clock Startup and Utility Software

6.1 Initial Startup Sequence

Before powering ON the Model 1094B, make sure that the chassis cover is installed and that inlet power is properly connected to the power inlet connector. The power switch is recessed to prevent accidental switching of power ON or OFF. When you slide the switch to ON, several things should happen, as listed in the sequence below:

- The four annunciator LED's initially should flash momentarily, then the OPERATE LED and UNLOCKED LED should light steadily.
- The LCD should display several introductory messages - see below.
- The Out-of-Lock Relay (Fault) will be in the out-of-lock (or faulted) position.
- Eventually, the UNLOCKED LED should extinguish.
- The Out-of-Lock Relay should change to Locked condition after a few minutes (depends how long the clock has been powered off).
- The LCD should indicate that the clock is Locked.
- The Stabilized LED should light steadily after a few minutes of locked operation.

6.1.1 Clock Time, Startup Mode

When the Model 1094B first starts, it will not indicate the correct time until it is locked to the GPS. Pressing the TIME key before the UNLOCKED LED is extinguished will produce the message:

TIME NOT AVAILABLE

For IRIG-B time, it will begin counting from zero, with the Julian Day also set to zero. This method was chosen so that there would be no mistake in interpreting that the clock was in startup mode. For example, at startup the time could indicate as follows:

```

000:00:00:01
000:00:00:02
000:00:00:03
.
.
.
265:13:45:21
265:13:45:22 (these values chosen for illustrative purposes only)

```

During a short period of time (from a few minutes to a few seconds) the displayed clock time may jump and add or lose some seconds as more satellites are acquired. This is normal, until the full set of ephemeris data is received by the GPS receiver from the GPS (satellites), at which the time the clock will be accurate. After running for a few minutes, the Stabilized LED will glow steadily, and the Out-of-Lock relay should close.

6.2 Front Panel Indication

6.2.1 LCD Display Indication at Startup

In the startup sequence, the LCD display should indicate similar to the messages shown below.

```

                ARBITER SYSTEMS GPS
                SUBSTATION CLOCK
followed by:
                COPYRIGHT (C) 2009
                ARBITER SYSTEMS, INC.
followed by:
                CLOCK STATUS
                STARTUP
followed by:
                CLOCK STATUS
                UNLOCKED 01 MIN

```

After this, the second line of the status display should change to UNLOCKED, or LOCKED depending on the previous operation, inactivity or if the clock has been moved. During startup, the UNLOCKED LED could turn OFF and ON. After a few minutes the STABILIZED LED should change from OFF to ON.

6.2.2 Other Display Indications When Unlocked

```

Time Display      TIME NOT AVAILABLE

Position Display  POSITION
                  NOT AVAILABLE

Event Display     PLEASE WAIT!
                  TIME ADJUSTMENTS

```

Status Display GPS RECEIVER STATUS
 ACQUIRING SATS

6.2.3 Status Display Indications

There are three indications when successively pressing the STATUS key. These are as follows:

CLOCK STATUS
STARTUP*

*The second line will change between STARTUP, to UNLOCKED (with time), to LOCKED.
as follows:

GPS RECEIVER STATUS
LOCKED

*Possible Receiver Status messages are:

BAD GEOMETRY
ACQUIRING SATS
POSITION HOLD
2D FIX
3D FIX
AUTO SURVEY

GPS tracking status message:

GPS TRACKING STATUS
TRACKING 12 SATS

*The number of tracked satellites can change from 0 to 12.

EEPROM status message:

EEPROM STATUS
CORR. ERRORS 0

If the number of corrected (CORR.) errors begins to climb, contact the factory about replacing the EEPROM.

6.2.4 Event/Deviation Display

There are separate displays when pressing the EVENT/DEVIATION key, depending on the setting. Successive events appear when repeatedly pressing the EVENT/DEVIATION key, or if configured for DEVIATION, it will indicate the 1-PPS Deviation (updates once per second). If there are no records, the display will indicate NO DATA.

Event Display

```
EVENT nnn
ddd:hh:ss.sssssss
```

Where:

```
nnn = event number(001 to 300)
ddd = day of year of the event(1 to 366)
hh = hour of the event(00 to 23)
mm = minute of the event(00 to 59)
ss.sssssss = second and fractional seconds of the event
```

Deviation Display

```
1 PPS:          0.00 μS
SIGMA:          0.00 μS
```

6.2.5 IRIG-B Time Data

IRIG-B time is immediately sent out, when the 1094B is powered ON, from any Timing Output port configured for IRIG-B as indicated above. Time will not be accurate until the Stabilized LED glows steadily.

6.3 Clock Status Display Mode

When first applying power to the Model 1094B, the display will indicate several startup messages, then will revert to Clock Status mode condition called *STARTUP*. After a short time, while the GPS receiver begins collecting data from the GPS, it will indicate either *UNLOCKED (XX Min)* or *LOCKED*. One of several fault messages may be displayed if they exist.

- Out of Lock
- Receiver Failure
- Antenna Short (low antenna voltage)
- Antenna Open (no current drawn by antenna system)

For additional information on internal faults, please see Table 2.2, Fault Indications and Messages, and Section 10.3.6, Status Mode Commands.

6.4 Time Display Modes

After establishing GPS satellite synchronization, display date and time information on the front panel by pressing the *TIME* key and scrolling through the four available displays. Press this key to select the time display mode (*UTC* or *Local*) time data (*Date/Time* or *Day of Year*).

6.4.1 Date and Time Display, Universal Time Coordinated (UTC)

This mode displays *UTC*, in the *Date and Time* format, as maintained by the United States Naval Observatory (*USNO*), as described below:

```
UTC DATE/TIME www
dd mmm yyyy hh:mm:ss
```

Where:

www = day of the week (Mon - Sun)
dd = day of the month
mmm = month (Jan - Dec)
yyyy = the year
hh = the hour (00 - 23)
mm = the minute (00 - 59)
ss = the second (00 - 59)

This mode displays UTC, Time of Year mode, without the application of daylight saving correction and local offset.

6.4.2 Time of Year Display, Universal Time Coordinated, (UTC)

This mode also displays UTC, in Time of Year format, which differs from the previous format as follows:

UTC DATE/TIME **www**
yyyy ddd:hh:mm:ss

Where:

ddd = day of the year (001 - 366)

This mode displays UTC, Time of Year mode, without the application of daylight saving correction and local offset. NOTE: Daylight saving and local-offset have no effect on this display.

6.4.3 Date and Time Display, Local Time

This mode displays the date and time after the daylight-saving correction and local offset have been applied, but in the same format as that of the Date and Time, UTC:

LOCAL DATE/TIME **www**
dd mmm yyyy hh:mm:ss

6.4.4 Time of Year Display, Local Time

This mode displays the time of year after the daylight-saving correction and local offset have been applied, but in the same format as that of the Time of Year, UTC:

LOCAL DATE/TIME **www**
yyyy ddd:hh:mm:ss

NOTE: Unless the daylight saving and local offset parameters have been set properly, displays in Sections 6.4.3 and 6.4.4 may not reflect the correct local time.

6.4.5 Daylight Saving-Summer Time

The Daylight Saving-Summer Time (DST) configuration feature has been expanded and allows the user to offset the clock time to local settings and yearly changes. The addition of AUTO allows the user to customize the DST/Summertime settings to match the requirements of locations in either Northern or Southern latitudes.

The DST/Summertime configuration can be changed through the serial port (1094B Utility software), or through the front panel keypad.

6.5 Position Display Modes

When the clock is first powered ON and acquiring satellites, the only position information available is the previous position, stored in the clock's setup EEPROM. This position information reflects the location of the receiver as determined by the last position while locked to at least four satellites. Displayed position is based on the most recent surveyed position.

Press the POSITION key to access longitude, latitude, and elevation data values. Repeatedly pressing the POSITION key scrolls the readout display continuously through these values. If pressed prior to acquisition of enough satellites to accurately determine and update position data, the display will indicate, POSITION NOT AVAILABLE.

Synchronization to a minimum of four satellites is necessary for precise determination of longitude, latitude, and elevation. When meeting this minimum satellite lock requirement, POSITION values will accurately correspond to the present antenna location.

6.5.1 Longitude Display

```
ANTENNA LONGITUDE
XXX° XX' XX.XXX" W*
```

Where:

*W for WEST, or E for EAST

6.5.2 Latitude Display

```
ANTENNA LATITUDE
XX° XX' XX.XXX" N*
```

Where:

*N for NORTH, or S for SOUTH

6.5.3 Elevation Display

```
ANTENNA ELEVATION
XXXXX.XX m WGS-84
```

Where the elevation is displayed referenced to the WGS-84 datum.¹

¹see <http://www.ngs.noaa.gov/faq.shtml#WGS84> for background information from National Geodetic Survey.

6.6 Application Software – 1094B Utility

1094 Utility application software was developed to configure the Model 1094B and to verify the configuration. From the verification, you can create a unique configuration for other clocks with the same performance characteristics.

6.6.1 Configuring with 1094B Utility Software

The following sections illustrate how to use the 1094B Utility software to configure the 1094B.

It is not necessary to have the 1094B locked to the GPS while configuring it. Time and position data, however, will not be accurate.

The most efficient method for configuring is through the use of the 1094B Utility software that accompanies the clock. It is also possible to program the Model 1094B by sending basic commands through a terminal, or terminal emulation program. These commands are listed in Chapter 10, Serial Communication and Command Set.

1094B Utility software allows you to read, write and verify operation on the Model 1094B. While it is idle, it releases the serial port on your pc for use. For pc's without serial ports, you will need to use a USB to serial converter.

To obtain the 1094 Utility application software, go to the Arbiter website and select Software Downloads under Site Navigation². Scroll down to Timing Software and select Model 1094B Software. Download the 1094 Utility to your computer. Double click the icon and in a few moments the program should start as illustrated in Figure 6.1. The 1094 Utility does not need to be installed.

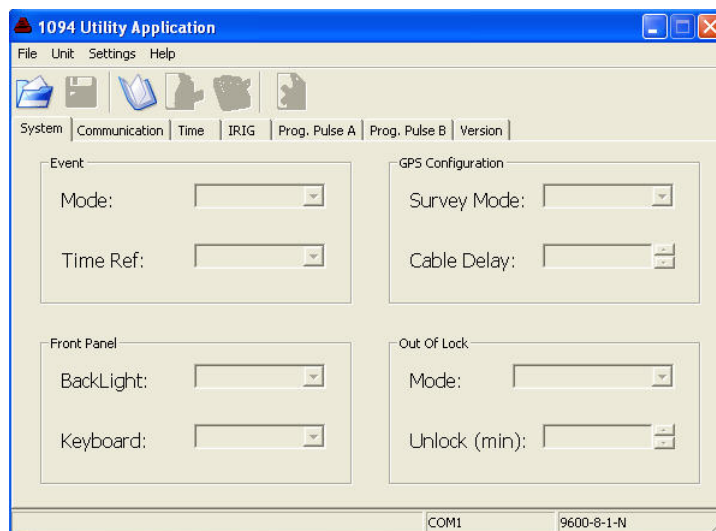

Figure 6.1: 1094B Utility Software, Opening Window

²Download from <http://www.arbiter.com/catalog/clock/1094/1094ware.php>

6.6.2 Establishing a Serial Connection

NOTE: To connect with the Model 1094B you must use a null-modem cable between the Model 1094B and computer; signals between Tx and Rx are crossed. Pin connections and functions are as follows:

PC	–	1094B
3, Tx	–	2, Rx
2, Rx	–	3, Tx
5, Gnd	–	5, GND

For computers without a serial port, you will most likely need to use a USB to serial converter. These devices normally associate a COM port number (on your computer) with the USB device. For the Windows XP operating system, you may look this up as described on the next page.

From the 1094 Utility, select **Settings > Serial Port > COM #**, choosing the correct COM port associated with your computer – see Figure 6.2. If your computer has its own serial port, choose that one. If you are using a USB-to-Serial converter, choose the one that is associated with your converter.

Make sure to go back and select **Settings > Baud Rate**, choosing the same baud rate as on the Model 1094B. To check the baud rate on your Model 1094B, press the SETUP key on the clock; the first menu should state, “SET SERIAL COM 1?”; press SETUP again and the second menu should state “SET SERIAL COM 2?”. Press ENTER to verify the port parameters for either COM1 or COM2.

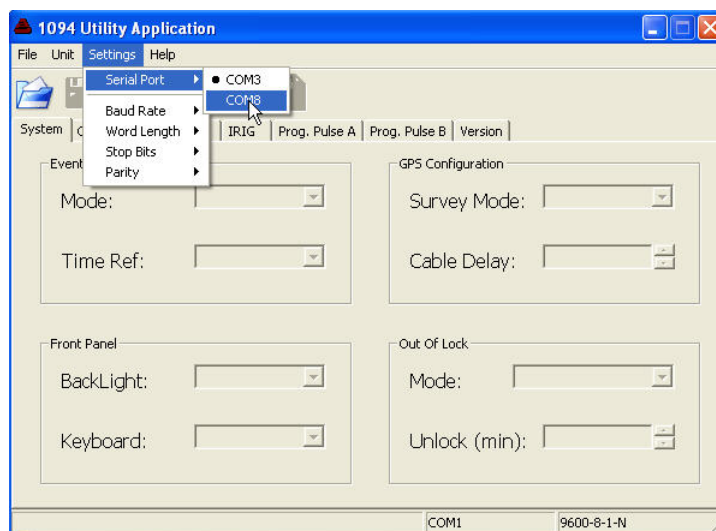

Figure 6.2: Connecting with the 1094B

See the next page for information on identifying the COM port being used by your USB-to-Serial adapter on your pc. The pc operating system in Figure 6.4 is Windows XP.

Using USB-to-Serial Adapters

If you are using a USB-to-Serial adapter, you may want to check which COM port Windows is using. If for some reason 1094B Utility software does not connect with the 1094B, you may want to check it. By using this method, you should be able to verify or reassign the COM Port being used by the USB-to-Serial adapter to an unused number.

Identifying COM Port Using Windows Device Manager

To check this, you will need to go to **My Computer > Manage > Device Manager > Ports (COM & LPT) > USB Serial Port (COM X)**. X should represent the COM port number. See Figure 6.3.

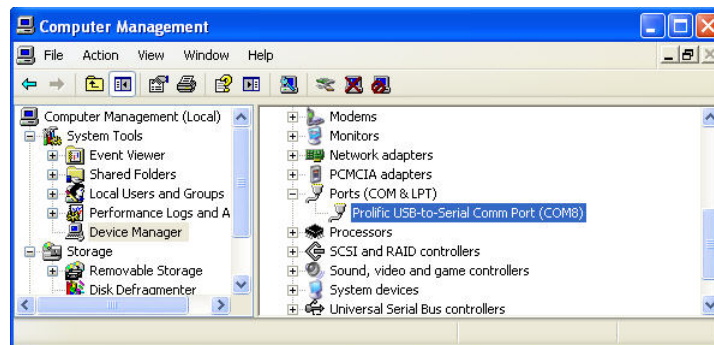

Figure 6.3: Windows XP Device Manager – identify COM port

Reassigning COM Port Number

To reassign the port, you will need to go to **My Computer > Manage > Device Manager > Ports (COM & LPT) > USB Serial Port (COM X) > (Right Click) > Properties > Port Settings (tab) > Advanced (button) > COM Port Number > select an available port as shown in Figure 6.4 below.**

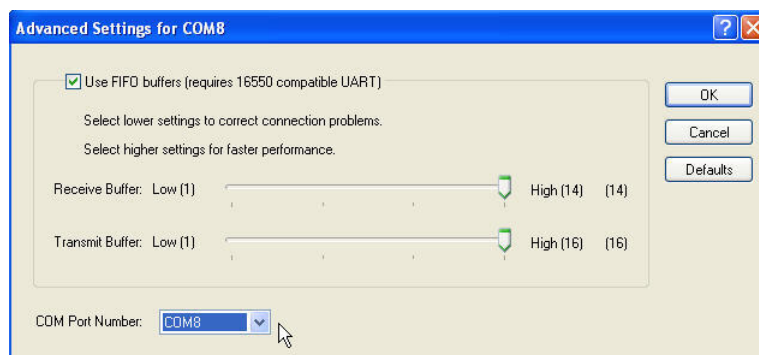

Figure 6.4: COM Port Assignment, Windows XP

6.6.3 Reading Clock Configuration

When first starting 1094 Utility there will be two functions open: **Open** and **Read**. **Open** selects a file to upload to a connected clock. Open a file by selecting **File > Open** or by clicking the **Open** icon (blue folder). **Read** allows you to poll the connected Model 1094B and download all of the configured information. You can find **Read** by either by selecting **Unit > Read**, or by clicking the **Read** icon. When selecting the **Read** function by either method, 1094 Utility will immediately try to read the configured settings in the connected clock. If it is successful, it will show a progress bar for a few seconds and then populate all of the values in the 1094 Utility windows. See Figure 6.5.

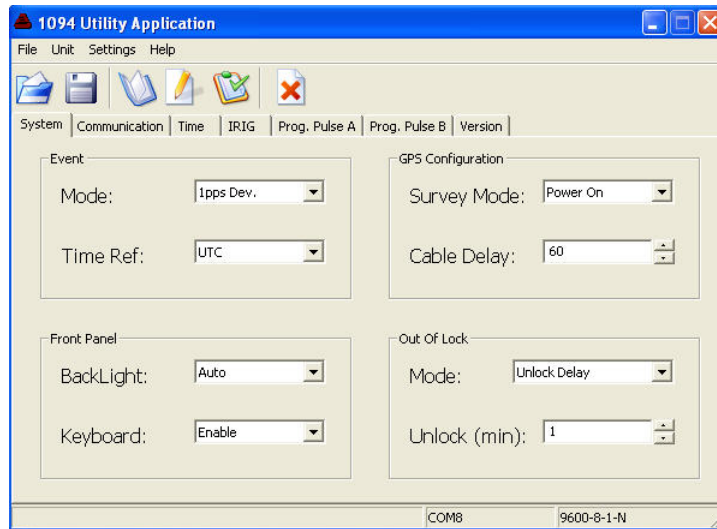

Figure 6.5: Reading the 1094B Configuration

If for some reason you get a message that the 1094B Utility software could not read the clock, make sure to check Settings at the top of the 1094B Utility window to verify (1) you are trying to connect using the correct COM port on your pc, (2) that you are using the correct baud rate, or other settings, and (3) that you have the correct cable(s) connected between the Model 1094B and the pc. Note that it must be a null-modem cable – see table in Section 6.6.2.

6.6.4 The System Screen

After selecting Unit > Read, or clicking the Read icon, the 1094B Utility will display the first tab information labeled System.

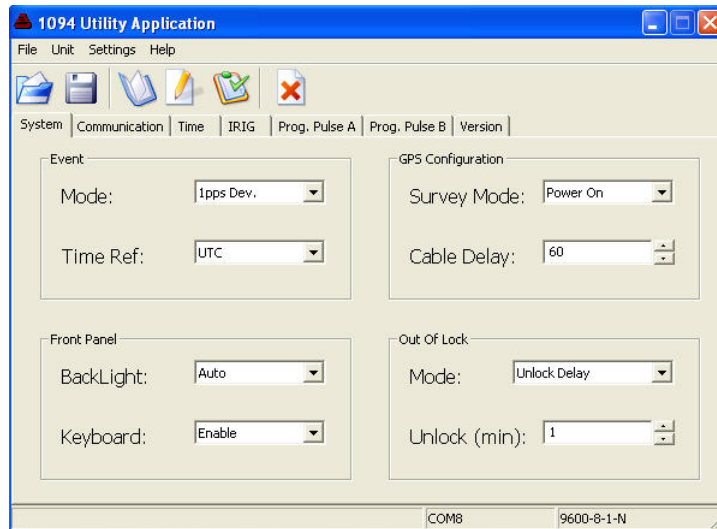

Figure 6.6: Reading the 1094B, System Screen

DEFINITIONS

Event Mode: Choose **1pps Dev.** to set the 1-PPS deviation mode; choose **Event** to set the event mode. **Time Ref.** has two selections to set the Event time reference of the clock as either **UTC** or **Local**. To clear all events, see **Clearing the Event Buffer** on the next page.

Front Panel: **BackLight** choices are **ON**, **OFF** or **Auto**, where **Auto** means that the backlight will turn on when you touch the keypad, and it will turn off after thirty seconds of inactivity. “**Keyboard**” selects either **Enable** or **Lock**, where **Lock** means that the keypad is disabled to prevent unauthorized use.

GPS Configuration: Sets the **Survey Mode** to **Power ON** or **OFF**. **Power On** performs a number of surveys every time the clock power is cycled on. **Cable Delay** sets delay to a number of nanoseconds dependent on the cable length; e.g. “24” (nanoseconds) for a 20-ft. cable.

Out-of-Lock: Sets the out-of-lock **Mode** to **OFF**, **Zero Delay** or **Unlock Delay**. **OFF** turns off the out-of-lock alarm, **Zero Delay** sets the clock to alarm immediately upon receiving an alarm condition, and **Unlock Delay**, sets a delay in minutes (from 1 to 99) for the relay to actuate upon receiving an alarm condition.

Clearing the Event Buffer

To clear all events stored in the event buffer, select **Unit > Clear Events**, or click the X icon on the right (above the **Prog Pulse A** tab) – see Figure 6.7.

While broadcasting event records, the buffer will continually be overwritten with new data. Therefore, you would not need to use the **Clear** feature while broadcasting event data.

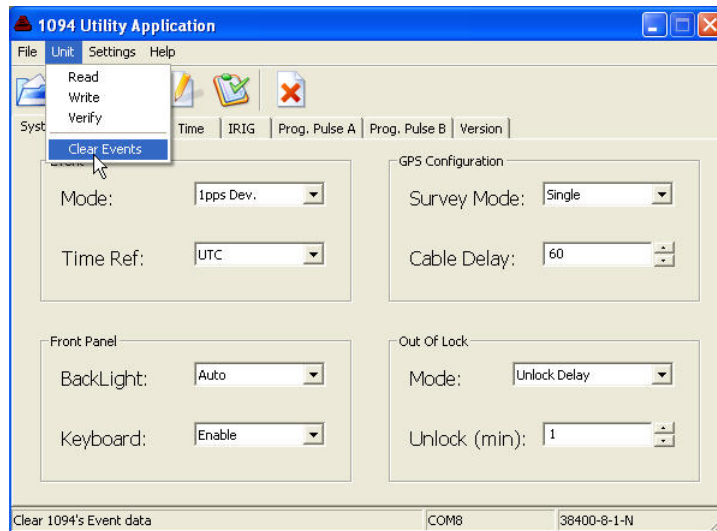

Figure 6.7: Clearing Events in the 1094B

6.6.5 The Communication Screen

Select the **Communication** tab to view and configure any communication parameters, including broadcast modes – see Figure 6.8. The 1094B Utility software reads from and configures either COM1 or COM2.

Select from a number of pre-configured broadcast messages, or two custom broadcast messages, which may be created through the scripting as described in Section 10.3.2.

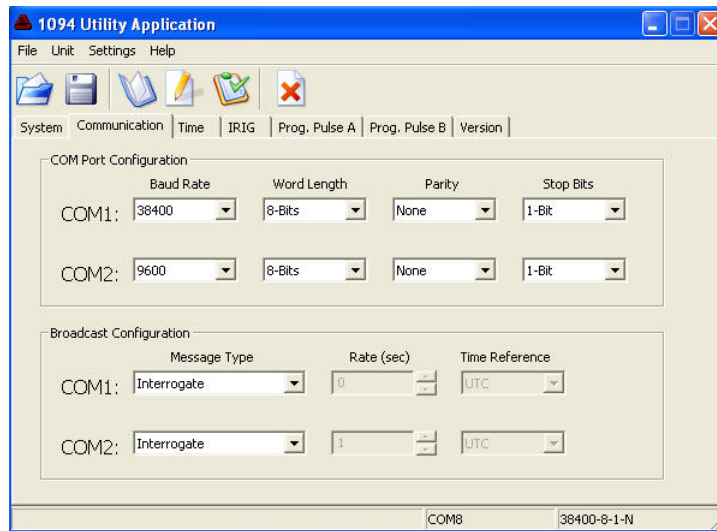

Figure 6.8: Communication Settings Screen

DEFINITIONS

COM Port Configuration: Allows for configuring COM Port parameters using this software utility; Sets baud rate, word length, parity and stop bits. 1094B ports do not use flow control.

Broadcast Configuration: Set Message Type according to the list of configured broadcast messages. Custom messages may also be configured. Set broadcast rate and broadcast time reference to either UTC or Local. To review information on customizing a broadcast string, see Section 10.3.1.

To review the actual custom string codes as they exist in the Model 1094B, use the mCB command in a terminal window, where $m = 0$ for Custom 1 and $m = 1$ for Custom 2.

6.6.6 The Time Screen

Select the **Time** tab to set up your Local Offset, which is the difference between UTC and your specific local time, and Daylight Saving Time (DST) offset. Local Offset should never change, however DST usually changes twice a year. DST can be turned Off, On, or set to Auto for automatic changeovers in your specific locale. The default DST setting is for North America.

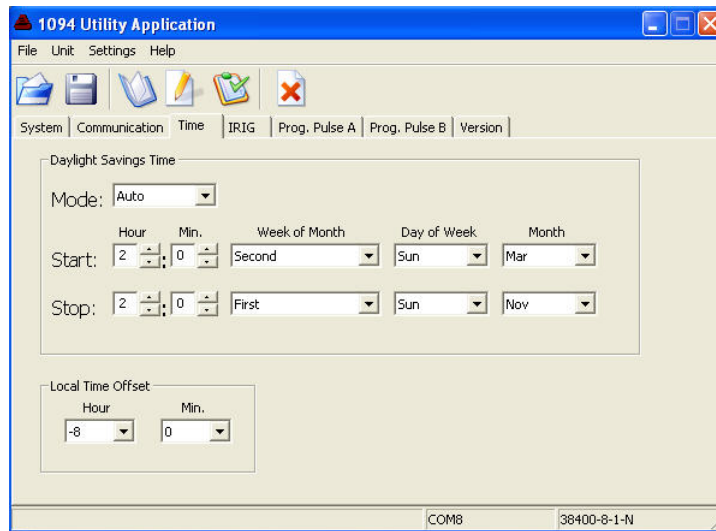

Figure 6.9: Time Adjustment Screen

Daylight Saving Time

In 2007 the U.S. Federal Government changed the start and stop dates to increase the number of days allotted to Daylight Saving Time (DST). Prior to the change, DST started at 2:00 a.m. the first Sunday of April and ended at 2:00 a.m. on the last Sunday of October. Currently, DST starts at 2:00 a.m. on the second Sunday of March and ends at 2:00 a.m. on the first Sunday of November. The result is an additional 4 – 5 weeks allotted to DST, depending on the specific year.

Since individual countries and regions have their own names, dates and times for the same effect as DST, the 1094B was designed to adjust for all these differences around the earth.

6.6.7 The IRIG-B Screen

Select the IRIG tab to set up how the 1094B sends out IRIG-B to your connected relays and IED's. Channel A refers to the two specific connectors labeled IRIG-B (unmodulated) and IRIG-B Mod (modulated). One mode of Prog. Pulse B allows you to configure IRIG-B differently than for Channel A (see Section 6.6.9), providing a separate and independent instance of unmodulated IRIG-B.

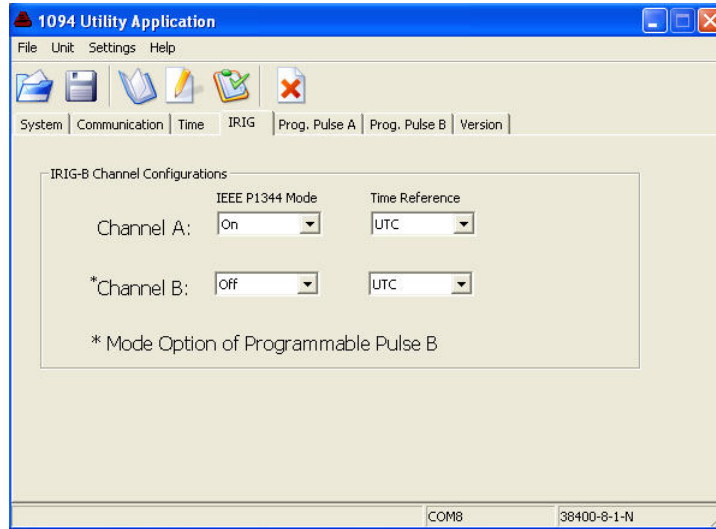

Figure 6.10: IRIG-B Adjustment Screen

IRIG-B Connection & Timing Information

For additional information on time codes, IRIG-B and connecting the Model 1094B to other equipment, please go to Chapter 8. Additionally, several application notes and white papers address connection issues in more depth, and are listed below. These may be obtained from the Arbiter website at <http://www.arbiter.com/ftp/datasheets>.

appnote101.pdf

irig_accuracy_and_connection_requirements.pdf

irig_b_spec_brief.pdf

If the link does not work correctly, you should be able to find them at <http://www.arbiter.com/ftp>.

6.6.8 The Programmable Pulse A Screen

Select the **Prog. Pulse A** tab to configure how the 1094B sends pulses out Channel A. There are two modes and seven pulse types from which to choose.

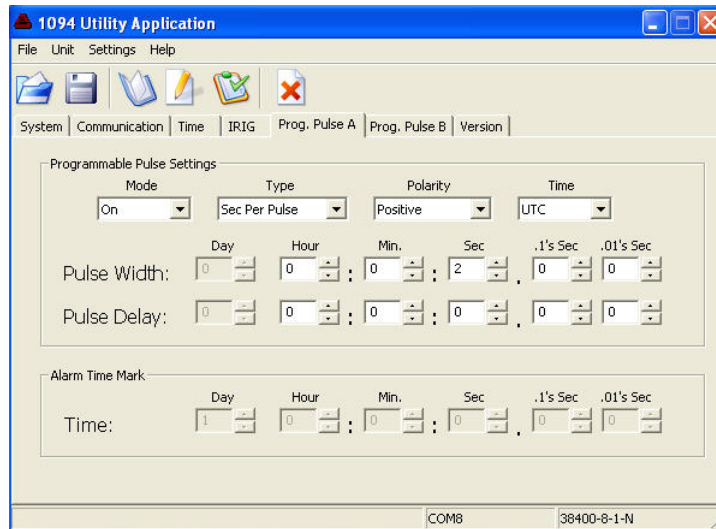

Figure 6.11: Programmable Pulse A Setup Screen

DEFINITIONS

Modes: (1) On and Off.

Pulse Mode Types: (1) Pulse per Second, (2) Pulse per Minute, (3) Pulse per Hour, (4) Pulse per Day, (5) Single Trigger, (6) Slow Code, and (7) Seconds per Pulse.

Polarity: Pulses may be set to transition positively or negatively.

Alarm Time Mark: Specify the time and date, UTC or Local, for a pulse event.

Pulse Width: Pulse width may be specified in 10 millisecond increments up from 10 milliseconds (0.010 seconds) to a full 24 hours.

Pulse Delay: Pulse Delay works in most modes, except in Alarm Time Mark and Slow Code. It delays the pulse by the selected value, after the top of the second, minute, hour or day depending on the chosen Pulse Type.

6.6.9 The Programmable Pulse B Screen

Select the Prog. Pulse B tab to configure how the 1094B sends pulses out Channel B. There are four modes and seven pulse types from which to choose. Prog. Pulse B is identical to Prog. Pulse A except that it includes two additional modes: (1) Frequency, and (2) IRIG-B. Channel B, IRIG-B is independent from Channel A.

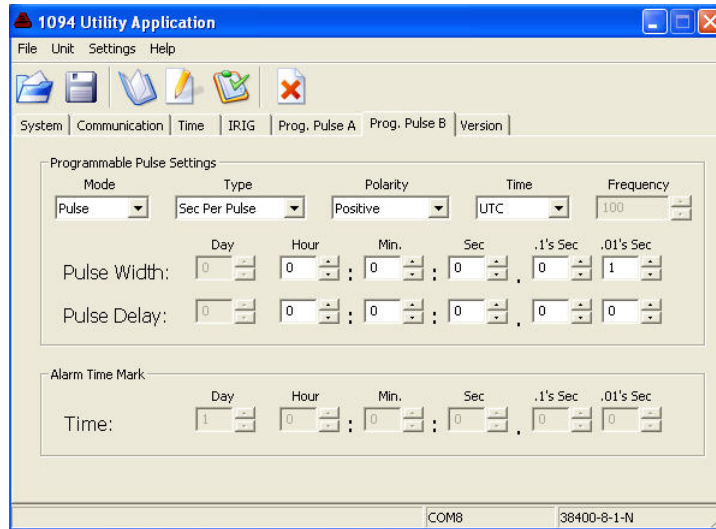

Figure 6.12: Programmable Pulse B Setup Screen

Modes: (1) Off, (2) Pulse, (3) Frequency, and (4) IRIG-B.

Pulse Mode Types: (1) Pulse per Second, (2) Pulse per Minute, (3) Pulse per Hour, (4) Pulse per Day, (5) Single Trigger, (6) Slow Code, and (7) Seconds per Pulse.

Frequency: Set frequency, from 1 to 1000, in pulses per second; no other settings are available. Pulses have 50 percent duty cycle.

IRIG-B: Select IRIG-B as Mode and go to IRIG-B tab, Channel B, to set up IRIG-B preferences.

Polarity, Alarm Time Mark, Pulse Width, and Pulse Delay: See definitions on Programmable Pulse A in Section 6.6.8.

6.6.10 The Version Screen

Choose the Version tab to view the firmware version of the Model 1094B, which is defined by the release date.

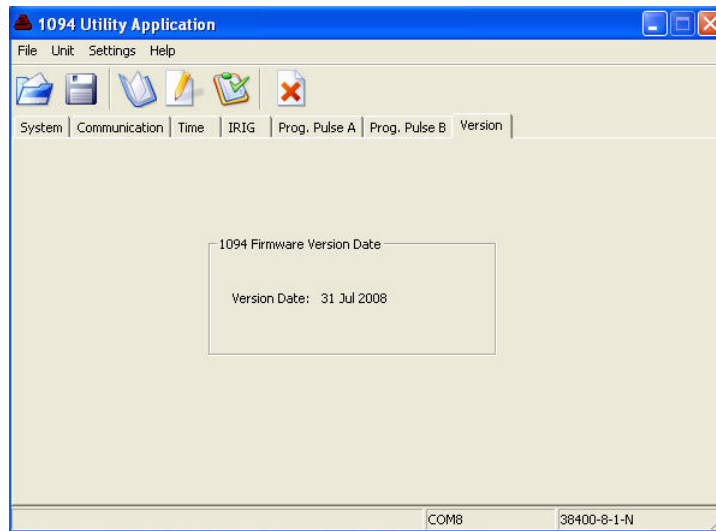

Figure 6.13: 1094B Version Display Screen

6.6.11 Setting to Factory Defaults

At some time it may be advisable to reset the Model 1094B to its original firmware configuration when it left the factory. To return the Model 1094B firmware configuration to factory defaults, follow the instructions enumerated below. After resetting, you can use the 1094 Utility to save the default configuration to file.

1. Power ON the Model 1094B.
2. Press the SETUP key when you see the first message displayed on the LCD, and display message should change to:
SET FACTORY DEFAULTS?
PRESS ENTER
3. Press the Enter key and the message should change to:
ARE YOU SURE?
YES = UP NO = DOWN
4. Press the UP key to complete the reset to defaults. The display should display the following message.
DEFAULTS COMPLETE
5. The factory default settings should now be restored.

6.6.12 Saving a Configuration File

After going to the trouble of configuring all of the settings in a new Model 1094B, the 1094B Utility allows you to save the configuration to a file.

To save a configuration file of the current clock setup, select **File > Save**, or click the Save icon in the 1094B Utility. When you do so, a Save Configuration window will appear for you to enter a file name and select a file location for the configuration file. The file will attach a “.1094” extension to the name.

6.6.13 Opening a New Configuration

You may Open a new configuration file for your Model 1094B either before or after reading from the connected clock. If you did not Read the 1094B first, make sure to check the Settings, especially the COM Port number.

1. Select **File > Open**, or click the Open folder icon, and choose the configuration file for uploading to the 1094B. The 1094B Utility will read the file and populate all of the configuration items in each tabbed display.
2. Select **Unit > Write**, or click the Write icon, and the progress window should indicate that the file is being written to the unit.
3. At the end, you can verify that the new configuration matches the file by selecting **Unit > Verify** or by clicking the Verify icon.

During the verification process, the program will compare all of the configurations in the Model 1094B with those of the file. A progress bar will indicate the comparison. At the end, a window will appear and identify any items that did not match.

4. With no verification problems, the Model 1094B should now be updated.

Programming Multiple Units

5. If you have multiple units to program, you should be able to connect the cable to the next unit and select **Unit > Write**, or click the Write icon. Assuming the other clocks have the same COM port parameters, programming should be very quick.

6.7 Uploading New Firmware using the 109x Loader ...

NOTE: *Warning! Do not halt the upload process once it has started or the Model 1094B may not be recoverable. This includes removing power from the 1094B, disconnecting the serial cable or turning off the computer during the uploading process. To recover you will be required to return the clock to Arbiter Systems.*

To upload new firmware to the Model 1094B, use 109x_loader_v####.exe; this loader and the new firmware may be downloaded from the Arbiter website. From the left side of the home page, in the selection window, select 1094B Software/Firmware. Be sure to read the release notes, which provide dates and fixes in the software or firmware.

6.7.1 Using the Uploader

1. Connect a null-modem cable between the computer and the serial port on the Model 1094B.
2. Start the loader program and click the folder icon, or select **File > Open**.

3. Locate the new 1094B firmware zip file (the loader automatically extracts the file) and click the **Open** button. The loader window should indicate some basic information about the file, including the firmware version by date. See Figure 6.14.

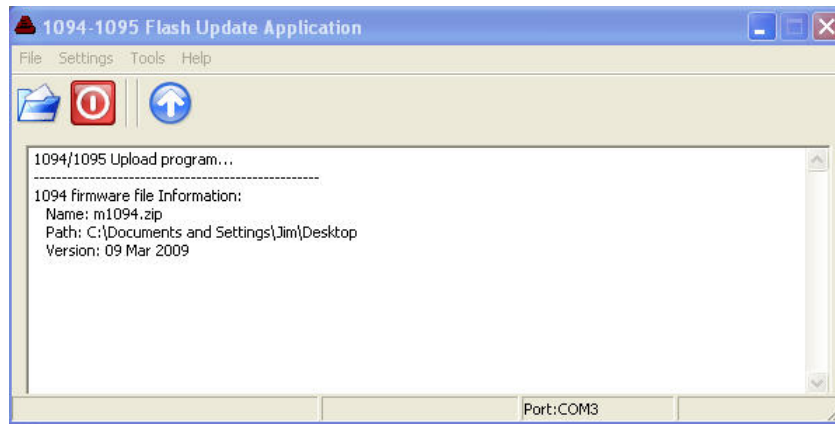

Figure 6.14: 1094B Loader with Opened Firmware File

4. Select **Settings > Serial Port** to choose the correct serial port.
5. Select **Settings > Baud rate** to choose the same baud rate as that of the 1094B.
6. Click the blue **UP** arrow to load the firmware into the Model 1094B. Figure 6.15 indicates what you should see after a successful uploading session. During the upload process, the program will show a progress bar that indicates erasing flash and then uploading the new firmware. The process time will vary due to the set baud rate and file size.

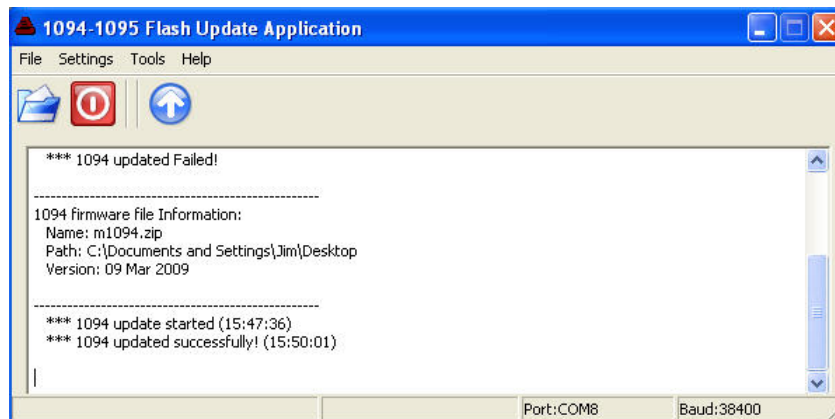

Figure 6.15: Successful Upload of New Firmware

7. After successfully uploading new firmware, close the 109x_loader program.
8. If the firmware did not successfully upload, first check the COM settings (i.e. COM port number and baud rate), and try again. Also, verify that the cable/connection is good.

Chapter 7

The Setup Menus

This section should guide you in configuring the Model 1094B operation using the SETUP Menus from the front panel. These menus allow you to configure the 1094B according to your preferences. Logically, using the setup menus should follow after setting any of the main board jumpers (see Chapter 5).

Two of the most common setup menus for any application are (1) configuring the Local Offset and Daylight Saving values, and (2) setting up the IRIG-B outputs for the correct time zone. For the 1094B to operate with the correct time in your location, you will need to configure the Local Offset (from UTC) and Daylight Savings, or Summer Time, changeover settings. There are a number of other settings that may be important to your application, however local time offsets are normally fundamental requirements. For a complete list of setup menus, see Table 7.1.

There are two methods of configuring the 1094B: (1) Using the lower row of keys on the front panel, and (2) remotely, by using either COM1 or COM2. For information on configuring the 1094B remotely through either COM1 or COM2, please refer to Chapter 10, Serial Communication and Command Set.

No.	Setup Menus	Setup Items
1	Serial COM1	Serial 1 Port Parameters and Broadcast
2	Serial COM2	Serial 2 Port Parameters and Broadcast
3	Local Time	Set Local Offset and DST/Summer Time
4	Out Of Lock	Set Time Interval Before Alarm
5	Backlight	Set to ON, OFF or AUTO
6	Cable Delay	Set Delay in Nanoseconds
7	Programmable Pulse A	Set Mode and Pulse Width
8	Programmable Pulse B	Set Mode and Pulse Width
9	IRIG-B Main	Set IRIG-B Time Zone and IEEE-1344
10	Set Auto Survey	Set Type of Survey and turn off
11	Event/Deviation	Set for either Events or 1 PPS Deviation

Table 7.1: Front-Panel Setup Menus

7.1 Setup Menus

Table 7.1, lists the various menus used to configure the operation of the Model 1094B. Other definitions follow the list that discuss how to begin configuring, the function of each key, and how

to escape the configuration process if necessary. After this introductory material, each menu is covered in detail.

7.1.1 To Begin Configuring

Press the SETUP key to enter the clock configuration menus, starting with communication port parameters (Set Serial COM1?).



SETUP: Press the Setup key repeatedly to scroll through the main menus. Also, after pressing SETUP once, you can press the UP or DOWN keys to scroll the menus. In numeric data entry mode, pressing SETUP moves the cursor to the left.

ENTER: Press the Enter key to confirm changes made within SETUP menus. Generally, pressing ENTER also advances the next parameter, or returns to the previous menu level. In numeric data entry mode, pressing ENTER moves the cursor to the right.

UP: Press the UP key, within the SETUP menus, to adjust numerical values upward, or to scroll upward through the available menu choices. The UP key also assists in navigating through main Setup Menus in normal order.

DOWN: Press the DOWN key, within the SETUP menu, to adjust numerical values downward, or to scroll downward through available menu choices. Also assists in navigating through main Setup menus in reverse order.

7.1.2 Numeric Data Entry Mode

Numeric data entry mode is activated anytime you enter a menu that requires a change in numerical value. When in this mode, the function of the SETUP and ENTER keys change to give left and right cursor control.

7.1.3 Default Firmware Settings

When shipped from the factory, and unless specified otherwise, the Model 1094B will be configured with a default set of values and features. This set of values and features are configured primarily through the front panel, lower row of keys, and alternately through either communication port. These default settings are listed in Table 7.2 below. For menu order, read table from left to right, and down.

7.1.4 To Exit Setup Menus

To exit any configuration menu without saving, press any key of the upper row of keys before pressing ENTER to change a value. To return to the configuration menus, press SETUP again. If you make a configuration error, you can scroll through the menus again and press ENTER when you find the menu you want to change.

Menu Item	Function	Menu Item	Function
COM1	DTR, 9600, 8, N, 1	COM2	DTR, 9600, 8, N, 1
Local Offset	none	Daylight Saving	OFF
Out-of-Lock	01 min.	Backlight	Auto
Cable Delay	60 ns	Prog Pulse A	Pulse Mode
Prog Pulse B	Pulse Mode	IRIG-B Main	1344 OFF, UTC
Auto Survey	Power On Survey	Event/Deviation	Deviation

Table 7.2: Default Firmware Settings

7.2 Set Serial COM1

Press SETUP key to configure Serial COM1. To enter the Set Serial COM1 menu, press the SETUP key and then the ENTER key. After this you will be able to choose between configuring the serial port parameters (PORT CONFIG) or selecting one of the broadcast options (BROADCAST). If you select BROADCAST, by pressing the DOWN key, you will also be able to select the preferred time zone in the broadcasted string (either UTC or LOCAL). See Figure 7.1.

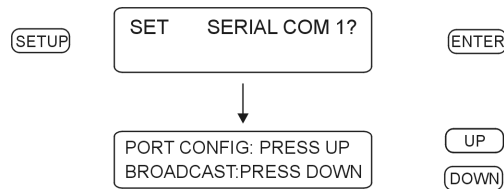

Figure 7.1: COM1 Setup

7.3 Set Serial COM2

Setup Serial COM2 in the same manner as for Set Serial COM1. From any view menu, press the SETUP key twice and then the ENTER key. Follow the on screen instructions as described above for Set Serial COM1.

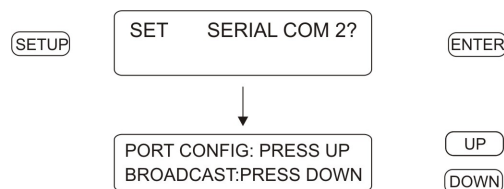

Figure 7.2: COM2 Setup

7.3.1 Set Broadcast Mode from Serial COM1

From the menu shown in Figure 7.1, press the DOWN key to select the Broadcast option and set up the 1094B to broadcast one of the available strings. Press the UP or DOWN keys to navigate through the seventeen choices for the broadcast strings, starting with INTERROGATE MODE (as seen in Figure 7.3). Interrogate Mode means that the 1094B is not broadcasting, but waiting for a command. When you have selected the desired broadcast string, press ENTER to apply the broadcast. For broadcast strings other than INTERROGATE MODE, two menus should follow: (1) select the time zone (UTC or Local), and (2) select the broadcast rate (1 to 9999 seconds between successive broadcasts, depending on type of broadcast).

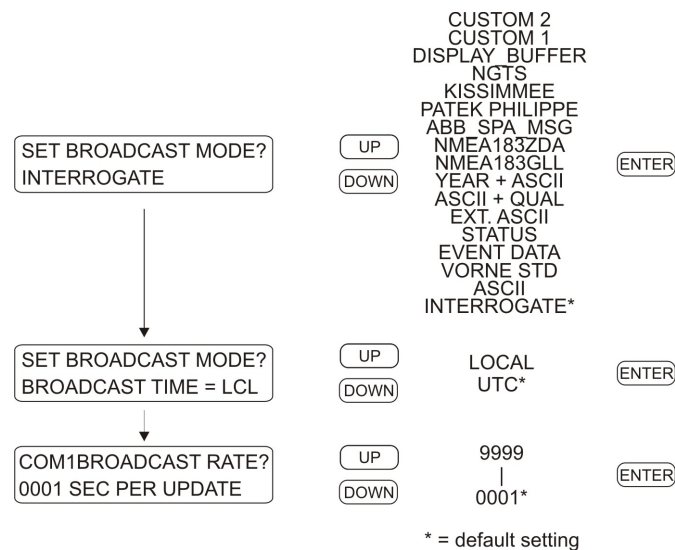

Figure 7.3: Broadcast Mode Setup

For a full list and discussion of these strings, please see Section 10.3.2, Broadcast Mode Commands.

7.3.2 Configure Serial COM1 Port Parameters

To set COM parameters, press the UP key as shown in Figure 7.1. Work through each menu to select your desired settings – see Figure 7.4.

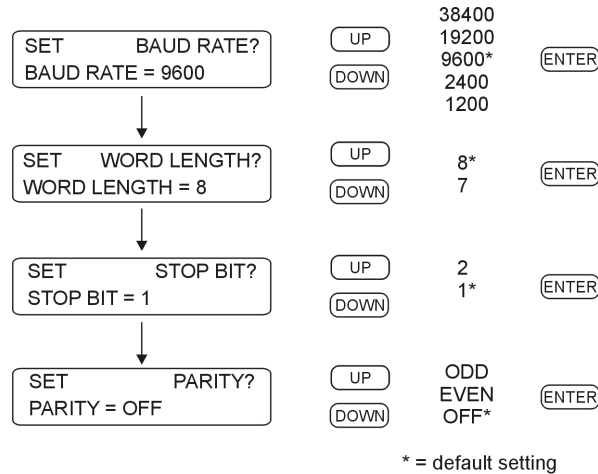

Figure 7.4: COM1 and COM2 Parameter Setup

Configure COM1 and COM2 in the same manner as shown in Figure 7.4. The “SET SERIAL COM2?” menu immediately follows the “SET SERIAL COM1?” menu. Another method of directly entering the SET SERIAL COM2? menu is to press the SETUP key twice.

7.4 Set Local Offset

The Local Offset equals the difference in time (in 15-minute increments) from UTC (or GMT) to your time zone. Locations west of the Prime Meridian have negative offsets and locations east of the Prime Meridian have positive offsets. For example, Karachi is +5 hours and New York is -5 hours offset from UTC – see Figure 7.5.

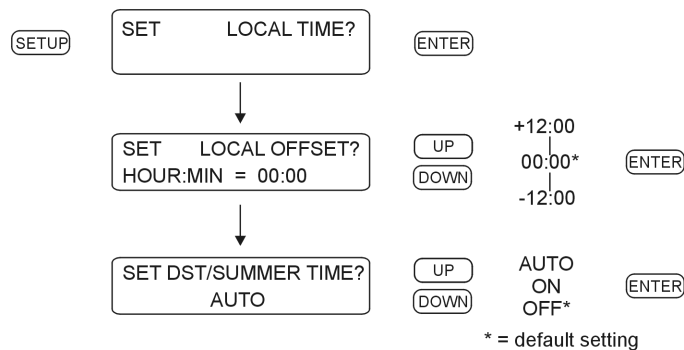

Figure 7.5: Local Time Setup

7.5 Set DST/Summer Time

Daylight Saving and Summer Time are hereafter referred to as DST. These settings follow immediately after setting the Local Offset, and are actually part of the Local Offset main menu. DST settings are normally used to advance and retard the time once each year. The menus in this section allow you to customize the clock time for your region in 15 minute increments over a plus or minus 12-hour interval.

Continuing from the Local Offset menu, follow the menus below to complete the DST setup. After setting the Local Offset, there are two basic values that are necessary to complete this configuration:

- DST Start Date and Time
- DST Stop Date and Time

The menu in Figure 7.6 illustrates how to set up the Start Date and Time. The Stop Date and Time menus are nearly identical except that the menu say “STOP” instead of “START,” the stop Month is “November”, and the stop week is “First.” Before setting up your DST feature, make sure that you understand when DST starts and stops in your region. In each menu, the list of selections are shown with each category.

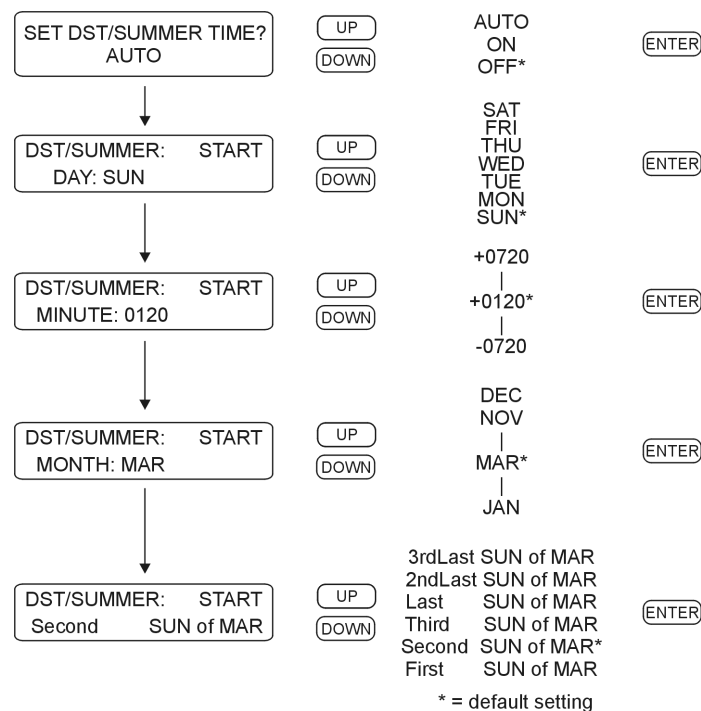

Figure 7.6: Daylight Saving and Summer Time Setup

7.6 Set Out of Lock

Set the Out-of-Lock time to control how the clock generates an alarm when it loses synchronization with the Global Positioning System. If set to OFF, the Out-of-Lock function will not give an alarm. If set to Zero Delay, then it will alarm immediately with an unlocked indication. If set to a value in minutes, then the 1094B will signal an alarm the configured number of minutes after an out-of-lock condition occurs. This is different than when the Model 1094B first operates at startup. During startup, the 1094B will immediately trigger an out-of-lock alarm since the clock is not locked to the GPS and the time is not accurate. See Figure 7.7.

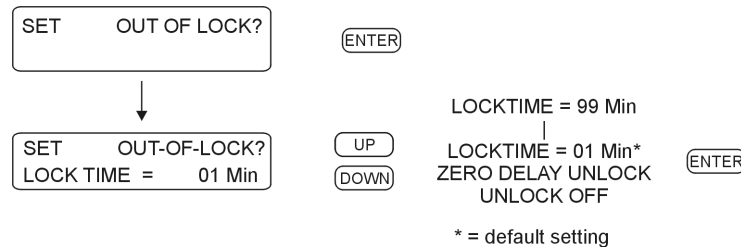

Figure 7.7: Out-of-Lock Time Setup

7.7 Set Backlight

The backlight function in the Model 1094B can be set to operate in three modes: Always ON, Always OFF and Automatic Shutoff (AUTO). AUTO is the most recommended setting, which causes the backlight to turn off automatically after period of 30 seconds of inactivity. See Figure 7.8.

NOTICE: The backlight has been specified with a 100,000 hour (11.4 year) life. To conserve backlight operation, configure the backlight for AUTO mode for normal operation.

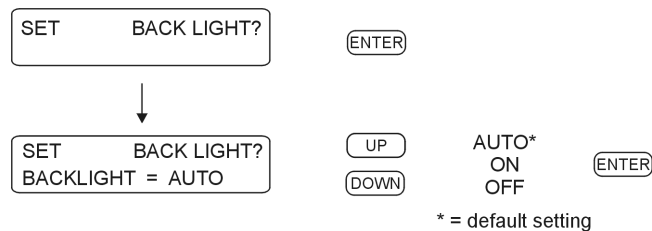

Figure 7.8: Backlight Setup

7.8 Set Cable Delay

GPS time is referenced to the time it is received by the antenna. Without setting the cable delay, the time would be late by the time it would take to travel the distance from the antenna to the GPS receiver. To accurately set the cable delay, you need to know the length and velocity factor of the antenna cable. For the cable supplied with the Model 1094B, calculate the delay by multiplying the the length of the cable (in feet) by 1.19 nanoseconds per foot. The result of this calculation will be in nanoseconds, and you can enter in the whole part of this number into the 1094B. See Figure 7.9.

Calculating Cable Delay

Use Formula 7.1 below for calculating cable delay for Arbiter-supplied RG-6 antenna cables.

$$(7.1) \quad T = \lambda \frac{1}{CKv} + 1ns$$

Where:

- T = Cable delay, in nanoseconds;
- λ = Cable length, in meters;
- C = Speed of light (3×10^8 meters per second);
- Kv = Nominal velocity of propagation (0.85).

One nanosecond is added to the calculated value to account for the length and velocity factor of the short connecting cable inside of the clock.

EXAMPLE: A 50-foot antenna cable would contribute the following delay; 50 ft. x 1.19 ns/ft = 59.5 (round up and enter 60).

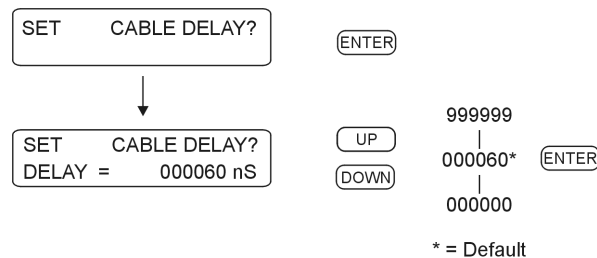

Figure 7.9: Cable Delay Setup

Numeric Data Entry Mode Numeric data entry mode is activated anytime you enter a menu that requires a change in numerical value. Press `SETUP` to move the cursor to the left; press `ENTER` to move the cursor to the right. Press the `UP` and `DOWN` keys to adjust values.

7.9 Set Programmable Pulse A and B

There are two independent programmable pulse outputs available in the Model 1094B: Programmable Pulse A and Programmable Pulse B. Pulses may be connected at the following ports:

- **Prog Pulse A**, Available on Timing Outputs 1 and 2, and on COM1.
- **Prog Pulse B**, Available on Timing Outputs 3 and 4, and on COM2.

Each of these outputs can be set in one of several modes, including:

7.9.1 Programmable Pulse A

- **Pulse Per Second**, pulses occur after a fractional number of seconds have elapsed each second.
- **Pulse Per Minute**, pulses occur at the designated time each minute
- **Pulse Per Hour**, pulses occur at the designated time, each hour
- **Pulse Per Day**, pulses occur at the designated time each day
- **Single Trigger**, pulses occur at the designated time each year
- **Slow Code UTC**, Slow Code is a programmable pulse with a voltage that is held high and goes low for 6 seconds on the day, 4 seconds on the hour and 2 seconds on the minute.
- **Seconds-Per-Pulse**, pulses occur after the chosen number seconds have elapsed, from 0 to 60,000, programmed in 10 millisecond increments.

7.9.2 Programmable Pulse B

Programmable Pulse B has all of the features of Programmable Pulse A, but also includes:

- **Frequency Mode**, allows the 1094B to produce a square wave on the chosen port, from 1 to 1000 pulses per second, 50 percent duty cycle.
- **Auxiliary IRIG-B Mode**, allows the 1094B to produce an alternate IRIG-B timing signal, different than what is set in Main IRIG-B. It allows for a different time zone and capability of switching the IEEE 1344 mode ON or OFF.

7.9.3 Programmable Pulse Signal Levels

Due to the different output ports available, the programmable pulse feature is able to produce pulses at the following signal levels:

- **5 V, CMOS**, available at all timing outputs.
- **300 V FET**, available at all timing outputs, for open drain signals.
- **RS-232 Levels**, available with Programmable Pulse A on COM1, and B on COM2.
- **RS-485 Levels**, available with Programmable Pulse A on COM1, and B on COM2.
- **Relay Contacts**, available with Programmable Pulse A only. See Section 5.3.

7.9.4 Programmable Pulse A or B Preliminary Setup

Except for two additional modes with Programmable Pulse B (i.e. Frequency Mode and Aux IRIG Mode), setting up the preliminary information for Programmable Pulse A and B is the same and will be covered here. You will need to choose the Pulse Mode, Pulse Polarity (positive or negative), Pulse Width and Pulse Time Zone. Pulse Width is adjustable in 10 millisecond increments from 0.01 to 600 seconds. See Figure 7.10.

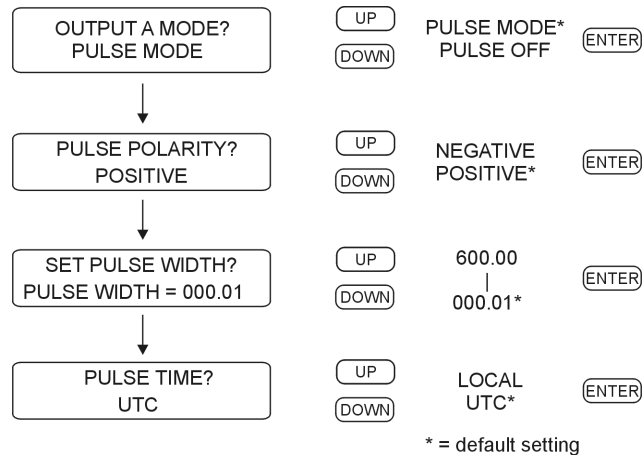

Figure 7.10: Programmable Pulse Setup, Preliminary Information

7.9.5 Setting the Pulse-Per-Second Mode

Use the Pulse-per-Second mode to produce a pulse every second at the set number of fractional seconds after the top of the second. Adjust the time delay after the on-time second mark at which the pulse will occur. Delay values range from 0.01 to 0.99 seconds. See Figure 7.11.

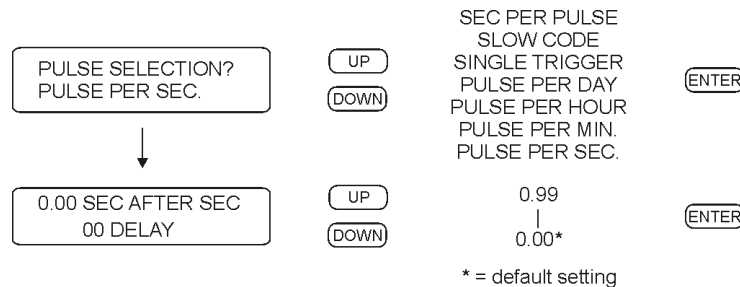

Figure 7.11: Programmable Pulse Setup, Pulse Per Second

Note: Pulse width can be from 0.01 to 0.99 seconds, otherwise it is set to 0.01.

7.9.6 Setting the Pulse-Per-Minute Mode

Use the Pulse-per-Minute mode to produce a pulse every minute, at the set number of seconds (and fractional seconds) after the top of the minute. See Figure 7.12.

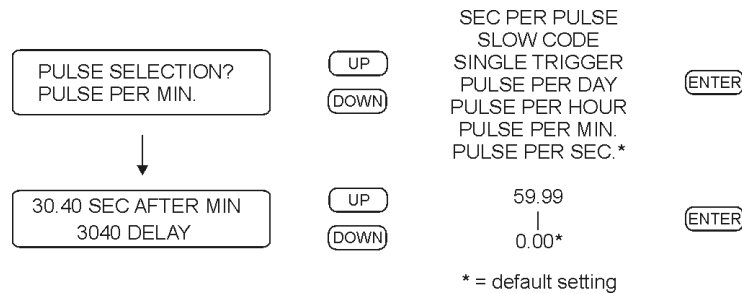

Figure 7.12: Programmable Pulse Setup, Pulse Per Minute

Note: Pulse width can be set in 10 millisecond increments from 0.01 to 59.99 seconds, otherwise it is set to 0.01.

7.9.7 Setting the Pulse-Per-Hour Mode

Use the Pulse-Per-Hour mode to produce a pulse every hour at the set number of seconds (and fractional seconds) after the top of the hour. See Figure 7.13.

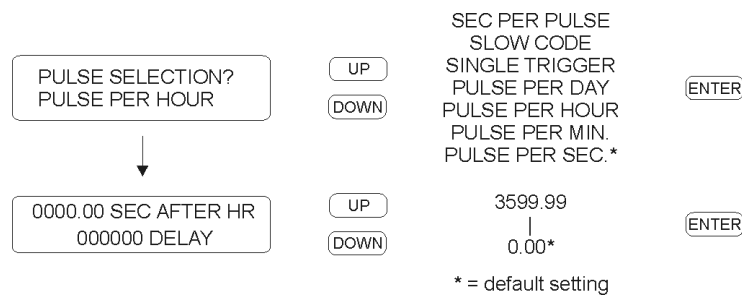

Figure 7.13: Programmable Pulse Setup, Pulse Per Hour

Note: Pulse width can be set in 10 millisecond increments from 0.01 to 600 seconds.

7.9.8 Setting the Pulse-Per-Day Mode

Use the Pulse-Per-Day mode to produce one pulse each day at the set number of seconds (and fractional seconds) after midnight. See Figure 7.14.

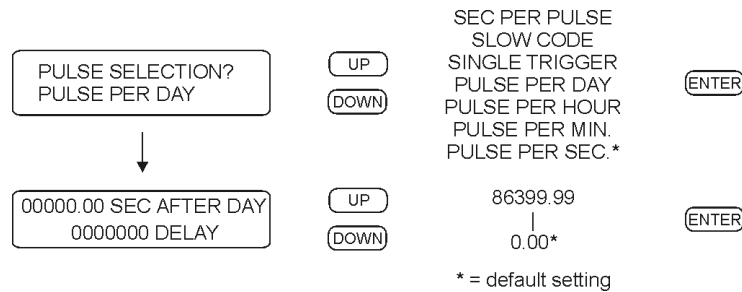

Figure 7.14: Programmable Pulse Setup, Pulse-Per-Day Mode

Note: Pulse width can be set in 10 millisecond increments from 0.01 to 600 seconds.

7.9.9 Setting the Single-Trigger Mode

Use the Single Trigger mode to trigger a pulse once per year at a specific day of the year and time of day. Setup menus include entries for Julian Day, Hour, Minute, Second and Fractional Seconds. To configure Single-Trigger mode settings, follow the procedure illustrated in Figure 7.15.

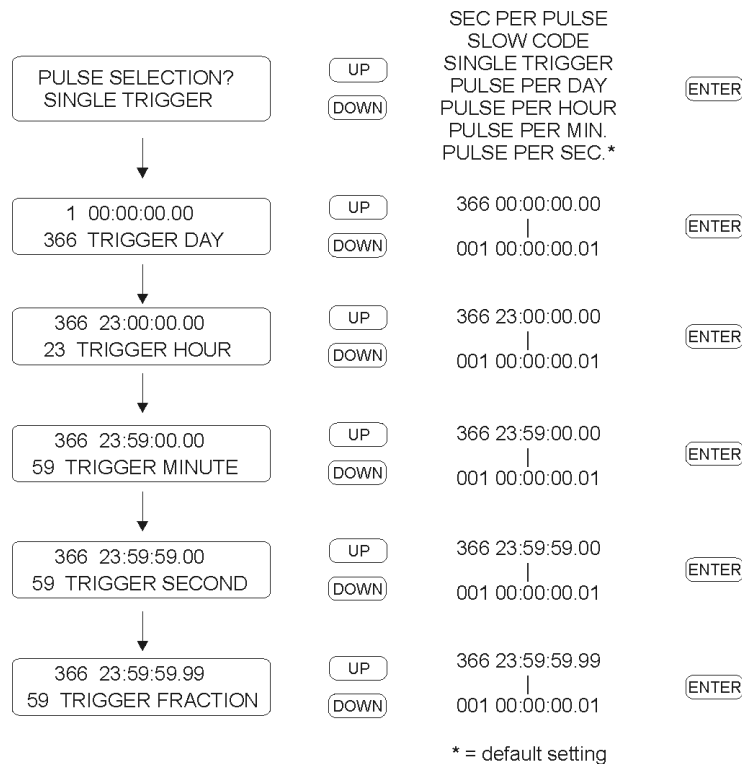

Figure 7.15: Programmable Pulse Setup, Single-Trigger Mode

7.9.10 Setting the Slow-Code Mode

Use the Slow-Code mode to trigger a pulse normally defined as follows: the output voltage is normally held high and it will go low for 2 seconds on the minute, 4 seconds on the hour and 6 seconds on the day. Set the time mode for either UTC or Local time. Slow-Code pulse polarity is always negative. Even if you select Pulse Polarity as Positive in a previous menu, it will be changed to Negative. See Figure 7.16.

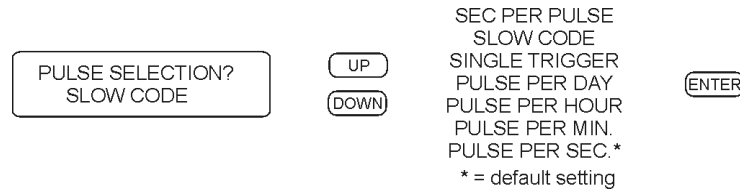

Figure 7.16: Programmable Pulse Setup, Slow-Code Mode

7.9.11 Setting the Seconds-Per-Pulse Mode

Use the Seconds-Per-Pulse mode to trigger a pulse after the chosen number of seconds, up to 60,000 seconds. Values evenly divisible by 60 will be on the minute; values evenly divisible by 3600 will be on the hour. Setting the time mode to UTC or LCL does not affect the output.

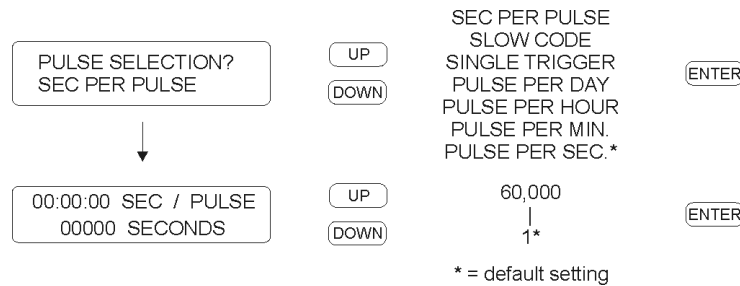

Figure 7.17: Programmable Pulse Setup, Seconds-Per-Pulse Mode

Note: Pulse width must be less than the pulse delay time, up to 600 seconds.

7.9.12 Setting the Frequency Mode, Programmable Pulse B

The frequency mode is available with Programmable Pulse B, not Programmable Pulse A. To use the frequency mode, you must select Programmable Pulse B from the main menus. The frequency mode broadcasts a square wave (at 50% duty cycle) from Output 3 and/or Output 4 at a rate of 1 to 1000 pulses per second. See Figure 7.18.

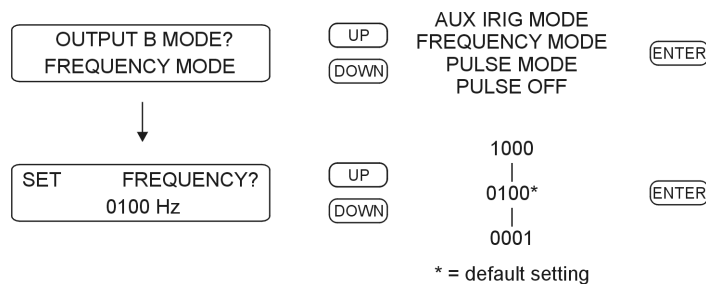

Figure 7.18: Programmable Pulse Setup, Frequency Mode

7.9.13 Setting the Aux IRIG Mode, Programmable Pulse B

The Model 1094B allows you to set up two different forms of the unmodulated IRIG-B time code. For example, one group of relays may require UTC time, and others may require the Local time. Also, this feature allows you to set up one output with the IEEE 1344 ON and OFF for the others. To use the Aux IRIG Mode, you must select Programmable Pulse B from the main menu, and set internal jumpers for Output 3 and/or Output 4. See Figure 7.19.

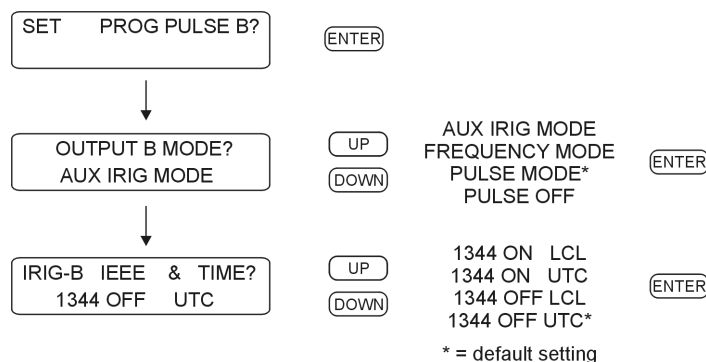

Figure 7.19: Programmable Pulse Setup, Aux IRIG-B Mode

Before configuring this option, please make sure to read over how to configure the internal jumpers for Programmable Pulse B mode. Also, determine which port or connector you would like to use. The Model 1094B allows setting up Programmable Pulse B from Timing Output 3 and/or 4 and also COM2, RS-485 only. If you would like to use Timing Outputs 3 and/or 4, please turn to Section 5.2, and if you wish to use COM2, please turn to Section 5.4.

7.10 Set IRIG-B Main

There are two separately-controlled IRIG-B outputs in the Model 1094B: “Set IRIG-B Main” and “Aux IRIG-B Mode.” Configure the main IRIG-B settings from this section, and auxiliary (AUX) IRIG-B mode from Section 7.9.13. In this way, you can set up two different time zones for IRIG-B, or you can independently turn the IEEE 1344 extension ON or OFF in either mode.

In the Model 1094B, IRIG-B is an electronic time code, synchronized to the GPS, that is transmitted each second. The four choices are (1) setting the time zone to UTC or Local, and (2) having the IEEE-1344 extension turned ON or OFF. To transmit the IRIG-B time code in the UTC time zone, the time will be offset from your local time determined by your locale. IEEE-1344 extension increases the amount of information contained in the time code, including the two-digit date and time quality. To use the IEEE-1344, your receiving equipment (e.g. relays, RTU’s, etc.) must be designed to receive the IEEE-1344 time code. See Figure 7.20.

NOTE: Make sure to set your main board jumpers correctly for each of the IRIG-B outputs. For information on setting the IRIG-B jumpers, see Section 5.2.

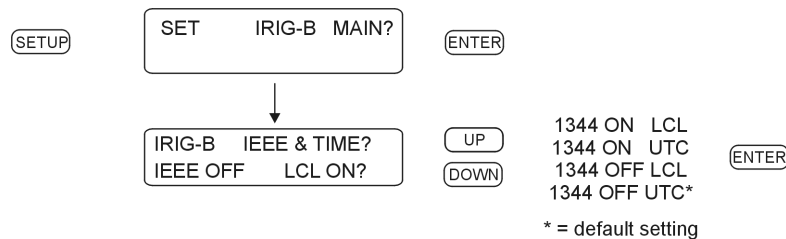

Figure 7.20: IRIG-B Configurations

For additional detail and definition on the different forms of IRIG-B, see Chapter 8, Timing, IRIG-B and Pulses.

7.11 Set Auto Survey

The Model 1094B GPS receiver uses an Auto Survey Mode that determines its position relative to the available Global Positioning Satellites. It has two operating modes that are selectable from the front panel or through either of the serial ports. These modes are (1) Power On Survey, (2) Turn Off Survey. See Figure 7.21.

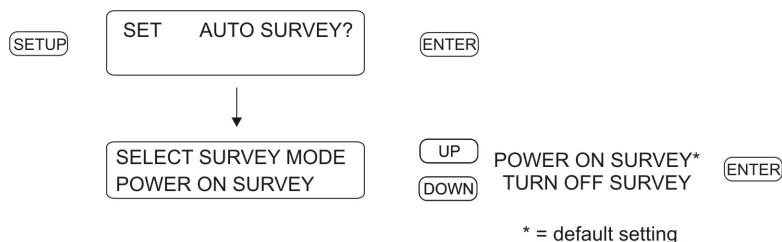

Figure 7.21: Auto Survey Configurations

Once the survey has been started, the Model 1094B will indicate that it is locked to the GPS, and continue to refine the surveyed position. The survey may also be turned off at any time by selecting Turn Off Survey from the front panel.

The Auto Survey averages a total of 10,000 (slightly over 2 1/2 hours) valid 2D and 3D position fixes. If the averaging process is interrupted, the averaging resumes where it left off when tracking resumes. Once the position is surveyed, the M12M timing receiver automatically enters the Position-Hold Mode. Once the antenna site has been surveyed in this manner, the user can expect a 2D position error of less than 10 meters with 95% confidence, and a 3D error of less than 20 meters with 95% confidence.

7.12 Set Event/Deviation

The event inputs are used to time a signal received by the Model 1094B based on the internal time base synchronized to the GPS. The accuracy of these timed events are within a microsecond with a resolution of 0.1 microsecond. See Figure 7.22.

A second feature is to use the event input to measure the deviation of a one pulse per second (1-PPS) signal.

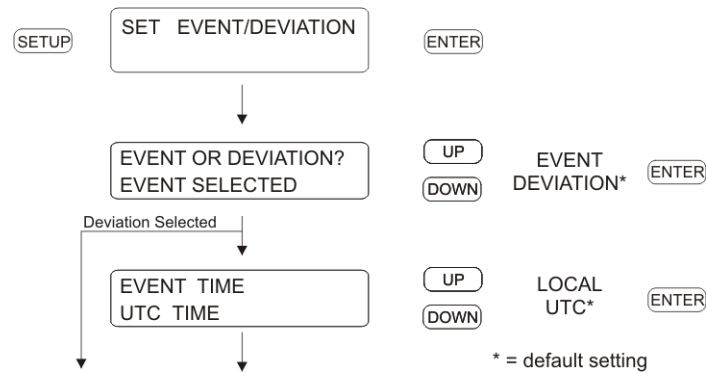

Figure 7.22: Event Configurations

Note: If you are configuring for event capture, the next menu will allow you to clear any previously stored events.

```

CLEAR EVENT DATA?
YES:UP NO:DOWN
  
```

NOTE: Events may also be cleared using serial port 1 or 2. See Section 10.3.5

7.12.1 Technical Details of Event/Deviation Timing

For additional technical details on Event and Deviation timing, see Section A.3.5, Relay Contacts and Event Inputs. For information on setting the Event/Deviation jumpers on the main board, see Section 5.5, Setting Internal Jumpers.

Chapter 8

Timing, IRIG-B and Pulses

8.1 Introduction

This section should help to identify specific terminology related to timing signals in the Model 1094B, and clarify how to synchronize your external equipment, or IED's. It should also answer some basic questions, such as:

- What are the different types of IRIG-B, and what are the differences?
- How do you connect multiple devices to one 1094B timing output?
- How far can you transmit timing signals?
- What kind of cabling and connectors should I use?

The steps involved in getting your devices synchronized to the GPS are fairly simple and should not take long to complete. To expedite the process, make sure that you know:

1. the type of timing signal each piece of equipment requires, and
2. how to enable the equipment to receive the timing signal.

Sometimes, you will need to set a physical jumper, or configure it through the instrument setup program. Some equipment can auto detect the timing signal, so that nothing else is required, other than connecting the cable.

8.2 Timing Output Description

The rear panel of the Model 1094B includes a number of different types of connectors as illustrated in Figure 8.1. Starting from the right-hand side, there is a power inlet connector, a GPS antenna connector, one event input connector, two DB-9 serial connectors, one SPDT relay connector and four timing outputs. Except for the GPS antenna connector, each connector can have multiple functions. In the sections that follow, you should be able to understand each function to correctly configure them.

8.2.1 Standard Inputs and Outputs

The 1094B has four separate outputs that can produce either digital or analog timing signals as described below. Digital signals include unmodulated IRIG-B, 1 Pulse per Second and

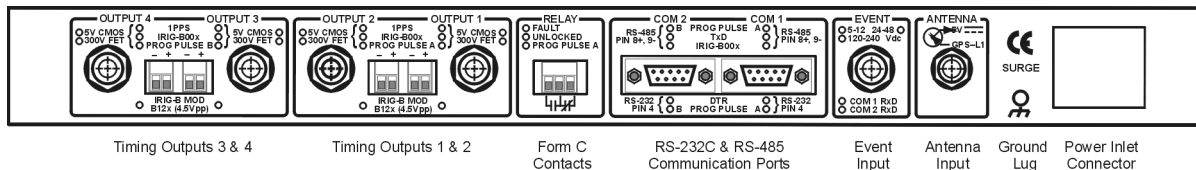

Figure 8.1: Rear Panel Description

Programmable Pulse; analog signals include modulated IRIG-B. Two of the outputs (3 and 4) can also source an independent instance of IRIG-B or frequency of from 1 to 1000 pulses per second. Finally, each digital output can be configured as either 5 Volt CMOS/level shift, or 300 Volt FET.

8.2.2 Digital Drivers – 250 mA Per Channel

Each of the four timing outputs uses a separate FDC6333C, N & P-channel Power Trench Logic level MOSFET, for digital signals (e.g. unmodulated IRIG-B, 1 PPS and Programmable Pulse), capable of 250 mA at 5 Vdc. Together, these four outputs together can provide up to one amp of drive current at TTL/CMOS levels. This permits you to connect a large number of IED's that would draw up to that amount of current. For example, if the IED timing signal input (e.g. IRIG-B003) requires 10 mA, one output channel should be able to support 25 identical devices.

8.2.3 Analog Drivers

Each of the four outputs also has a separate analog driver to be used exclusively for *modulated IRIG-B signals*. The analog driver is an Analog Devices AD8532, single-supply, dual-output amplifier, which supplies a 4.5 Volt peak-to-peak (Vpp) signal through a 19.6-ohm source resistor. As the load current increases (by adding external IED's), more voltage is dropped across the clock source resistor and the drive voltage decreases. Due to this change in peak-to-peak output, it is sometimes essential to match the modulated IRIG-B output voltage to the required IED input. Make sure to check the equipment specification and verify the input voltage levels. Table 8.1 shows how the actual drive voltage varies with increasing load current. For IED's with a restricted input range, it may be necessary to match the available drive voltage to the IED through a small dropping resistor.

Drive Current, mA	Actual Drive Voltage, Vpp
0	4.5
1	4.48
10	4.3
100	2.54

Table 8.1: Drive Current vs. Voltage

8.3 Output Signal Description

The Model 1094B has four independent outputs subdivided into two groups: (1) Outputs 1 and 2 can be configured for IRIG-B, 1 PPS or Programmable Pulse A; (2) Outputs 3 and 4 can be configured for IRIG-B, 1 PPS and Programmable Pulse B. Programmable Pulse A has two modes: ON and OFF. Programmable Pulse B adds to that two additional modes: Frequency and IRIG-B. Pulse mode is useful for timing individual pulses at specific intervals or at a specific time of day or year. Frequency mode provides from 1 to 1000 pulses per second (Prog. Pulse B), at a 50% duty cycle. Programmable Pulse B may also be used as a second unmodulated IRIG-B configured independently from the standard IRIG-B.

Programmable pulse modes are similar to 1 PPS only they have an adjustable period and pulse width. Modes include, pulse per second, pulse per minute, pulse per hour, pulse per day, single trigger (once per year), slow code and seconds per pulse.

8.3.1 IRIG-B Description

IRIG-B is a complete serial time code that occurs once per second and, depending on the configuration, contains the day of year, hours, minutes, seconds, year and other important information. The Model 1094B transmits Format B with four variations as seen in Table 8.2. Note that with the newer IRIG Standard 200-04, two of the designations have changed: the older B000 has become B004 and B120 has become B124.

Code, Old/New	Signal Type	Code Components
B000/B004*	Pulse width code, No carrier	BCD _{TOY} , CF, SBS
B003**	Pulse width code, No carrier	BCD _{TOY} , SBS
B120/B124*	Sine wave, modulated, 1 kHz	BCD _{TOY} , CF, SBS
B123**	Sine wave, modulated, 1 kHz	BCD _{TOY} , SBS
*IEEE 1344 ON, **IEEE 1344 OFF		

Table 8.2: IRIG-B Time Code, Types Available

The IRIG-B time code consists of 100 bits produced every second, 74 bits of which contain various time, date, time changes and time quality information of the time signal. Consisting of logic ones, zeros and position identifier bits, the time code provides a reliable method of transmitting time to synchronize various equipment.

There are three functional groups of bits in the IRIG-B time code, in the following order: Binary Coded Decimal (BCD), Control Function (CF) and Straight Binary Seconds (SBS). The BCD group contains only time information including the seconds, minutes, hours and days, recycling yearly. The CF group contains other time-related information including year, time quality, leap year, pending leap seconds and parity. The SBS consists of the total elapsed seconds, restarting daily. Position identifiers separate the various components of the IRIG-B time code.

8.3.2 Modulated and Unmodulated IRIG-B

Figure 8.2 illustrates the primary differences between modulated and unmodulated IRIG-B. You will notice that while modulated IRIG-B (B120) is distinctive because it uses a sinewave carrier signal of 1 kHz, it is similar to unmodulated IRIG-B (B000) since the peak-to-peak values of the carrier follow the same form as the digital waveform, where the information is contained.

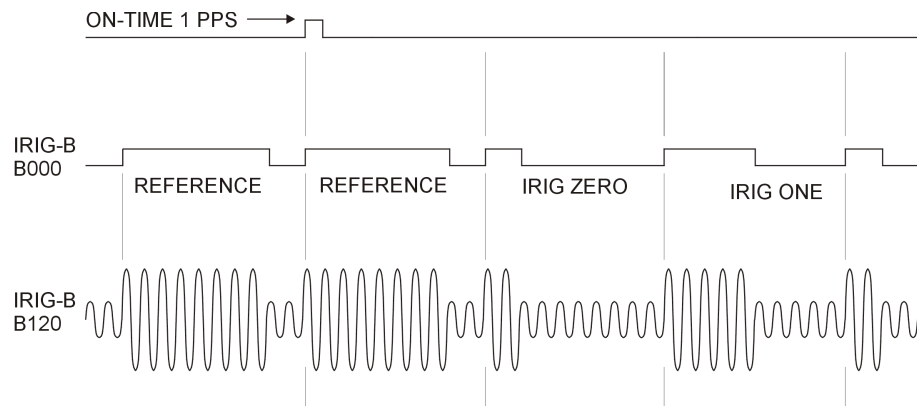

Figure 8.2: IRIG-B Waveforms

8.3.3 IRIG-B IEEE 1344 Extension

As mentioned above, the IEEE 1344 enables extra bits of the Control Function (CF) portion of the IRIG-B time code. Within this portion of the time code, bits are designated for additional features, including:

- Calendar Year (old method, now called BCD_{YEAR})
- Leap seconds, and Leap seconds pending
- Daylight saving time (DST), and DST pending
- Local time offset
- Time quality
- Parity
- Position identifiers

To be able to use these extra bits of information, relays, RTU's and other equipment receiving the time code must be able to decode them. Consult your equipment manual to determine if the IEEE 1344 feature should be turned ON in the Model 1094B. To view details of the IEEE Std 1344-1995, please check with the IEEE.

NOTE: To download a copy of the IRIG-B 2004 specification, please use the link to the Arbiter web site.

http://www.arbiter.com/catalog/timing_freq_index.php and click on IRIG-B.

8.3.4 1 Pulse per Second (1 PPS)

A one Pulse-Per-Second timing output signal is very simple in concept. It is a digital bit transmitted every second with a pulse width of 10 milliseconds. Probably the most critical part of this signal is that it is “on time” at the rising edge, compared with the signal from the Global Positioning

System (GPS). To produce a 1 PPS signal from the Model 1094B, use either Prog. Pulse A or Prog. Pulse B. See Figure 8.2 for a comparison between unmodulated IRIG-B and 1 PPS.

8.3.5 Programmable Pulse (Prog. Pulse)

The Model 1094B has two independent programmable pulse functions: Programmable Pulse A and Programmable Pulse B. Programmable Pulse A has a pulse mode that allows various pulse timing options from pulses each second up to one pulse per year. Programmable Pulse B has the same two modes as Programmable Pulse A except that it has a Frequency Mode and Auxiliary IRIG Mode. The Programmable Pulse A and B feature set is shown in Table 8.3 below.

Other possible signals include controlling a 300-Volt FET for high-level signal handling with any of the available digital signals. The Programmable Pulse feature also has an adjustable pulse width in 10 millisecond increments from 10 milliseconds to 10 minutes in duration.

Programmable Pulse Function	Prog Pulse A	Prog Pulse B
Pulse Per Second	yes	yes
Pulse Per Minute	yes	yes
Pulse Per Hour	yes	yes
Pulse Per Day	yes	yes
Single Trigger	yes	yes
Slow Code	yes	yes
Frequency Mode	no	yes
Aux IRIG Mode	no	yes

Table 8.3: Programmable Pulse Output Functions

8.3.6 Programmable Pulse with 300-Volt FET, Setup

With this setting you can perform high-level switching at any of the four timing outputs, setting the 1094B to trigger a pulse at the required time of day or time interval. Connect a voltage of up to 300 volts and pull down a signal with the Open Drain 300-Volt FET. Remember to connect the FET with suitable protection against overvoltage transients and over current conditions. To set timing output jumpers for programmable pulse with 300-Volt FET, see Section 5.2. Next, you will need to configure the type of programmable pulse through the Setup Menus. See Section 7.9 for more details on setting up the programmable pulse through the Setup Menus. Programmable Pulse features may also be set up remotely using 1094 Utility through either serial communication port. For setup using 1094 Utility, see Section 6.6.8 or Section 6.6.9.

8.3.7 300-Volt FET Connection – Setup and Protection

For setup diagrams see Appendix D, External Switching Applications. Open-drain outputs have internal protection against over-voltage. Maximum peak ratings are 10 A and 400V. External protections (current-limiting resistors, surge suppression diodes, snubbers, etc.) must be provided by the user, if required, to ensure that maximum ratings are not exceeded even momentarily. Also, before using the 300-Volt FET, please check the data sheet of the IRF740S used in this application.

8.4 Connecting Outputs

The Model 1094B comes equipped with two types of output connectors: BNC female and screw terminals. BNC connectors are compatible with most coaxial cables. Terminal connectors are compatible with twisted pair cabling, in which the wires are stripped bare, tinned and fixed into the correct screw terminal positions.

NOTE: If using a shielded, twisted-pair cable (like Belden 8760), DO NOT connect the cable shield at the clock. Always connect a cable shield at the receiving equipment (IED) grounding point.

8.4.1 Attaching Cables to Screw Terminals

Prepare the twisted pair cable by stripping back at least 1/4 inch of the insulation and any shielding. DO NOT tin the bare wire with solder. Tighten the screws down on the wire. *Do not ground the shield to the Arbiter clock.*

8.4.2 How Far Can I Run IRIG-B Cabling?

Some important considerations for transmitting IRIG-B over long distances are: (1) resistive losses in cabling, (2) electromagnetic interference, (3) propagation delays and (4) installation and maintenance costs.

For details on distributing IRIG-B signals over long distances, see application note, AN101, Distributing Timing Signals in a High-EMI Environment. Download file *appnote101.pdf* at the following link:

<http://www.arbiter.com/ftp/datasheets/>

For important considerations about IRIG-B connections, distribution of signals and accuracy, download the file, *IRIG-B_accuracy_and_connection_requirements.pdf* at the following link:

<http://www.arbiter.com/ftp/datasheets/>

8.4.3 Synchronizing Multiple Devices From One Masterclock Output

In many installations, master clock signals (e.g. the 1094B) are “fanned out” to a number of devices. This method makes more efficient use of the clock synchronizing capability since the clock drivers are designed to handle multiple loads. The exact number of possible loads must be determined from the input impedance of each connected IED, which sets the current drawn from the specific 1094B output. In calculation 8.1, the device current (I) is calculated from the output voltage (V) and the input impedance (Z) of the IED, which is 5 kilohms.

$$(8.1) \quad I = V/Z = 5 \text{ Volts}/5000 \text{ Ohms} = 0.001 \text{ Amps}(1 \text{ mA})$$

If you were to connect ten of the same devices to the same output, then the total current drawn would be $10 \times 0.001 \text{ A} = 0.01 \text{ A}$ (10 mA).

8.4.4 Connecting Unmodulated IRIG-B

To drive multiple loads from a single 1094B timing output, make sure they are wired in parallel. Some call this “daisy-chaining”, however the idea is to drive all of these loads in parallel from the

single output. It is much simpler to connect loads to unmodulated IRIG-B than for modulated. This is because all of the loads are driven at the same voltage and each draws current directly from the transmission line.

To determine capacity for Unmodulated IRIG-B, follow these steps:

1. determine the impedance (or resistance) of each connected load
2. divide the drive voltage (5 V) by the resistance of each device
3. sum up all the load currents for the total current for one clock output
4. the total current should not exceed 250 mA.

Another method is to determine the lumped impedance of all of the connected IED's in parallel. Then, determine the overall current by dividing the drive voltage (5 V) by the computed lumped impedance value. This current should not exceed 250 mA.

Techniques for Lightly Loaded Outputs

For lightly loaded outputs, you may want to consider intentionally loading down the output with a resistor. This technique tends to calm any overshoot and ringing that would otherwise occur without it. For example, placing a 50-Ohm resistor across the load would increase the output current by 100 mA, however it would require a resistor that would handle that load. Consider using at least a 1-Watt resistor in this example. Two possibilities exist: (1) placing a loading resistor across the load itself, and (2) placing a source resistor in series, at the output of the clock. A source (series) resistor would also tend to drop the available voltage to the device, so make sure that the voltage is adequate with suggestion #2.

8.4.5 Connecting Modulated IRIG-B

The total load capacity for the modulated IRIG-B driver depends on the type and number of loads. The main difference in computing the load capacity for modulated IRIG-B and unmodulated IRIG-B is that modulated IRIG-B decoders tend to be sensitive to the peak-to-peak voltage. With adding loads, the 1094B modulated driver produces more current, which is passes through the internal source resister, dropping the available output voltage. The open circuit voltage (i.e. no loads) is approximately 4.5 V_{pp}, so any connected loads will cause the available voltage to drop. The available output voltage (V_{pp}) with a known current is calculated in 8.2.

$$(8.2) \quad V_{pp} = 4.5 V_{pp} - I(19.6 \text{ Ohms})$$

Therefore, if you had 10 mA of load current (I load) the available voltage (V_{pp}) would be 4.304 V_{pp}. If the load current equals 100 mA, then the available voltage would be 2.54 V_{pp}. So, you can see how the increasing load current (i.e number of loads) affects the available drive voltage at the clock output. See also Table 8.1.

8.4.6 Wire Losses

Another factor affecting the available voltage is the resistive losses through the cabling. Wire has a certain resistivity associated with it that is determined by its metallic composition, and resistance determined by the diameter and length. For example, single-strand, 22 AWG (bare, enamel-coated) copper wire has a resistance of approximately 16.2 ohms per 1000 feet. To compute the loss we

must include both wires in the connection, signal and return. For coaxial cabling, the resistance of the center conductor is rated differently than the shield. For a twisted pair, both of them should essentially have the same resistance per cut length. If we use a twisted pair of 22 AWG (copper as above), then the available voltage (at 100 mA of current) for 500 feet of wire including the source resistor is calculated in 8.3.

$$(8.3) \quad V_{pp} \text{ available} = 4.5 - I(19.6 \text{ source}) - I(16.2 \text{ wire}) = 0.92 V_{pp}$$

So, you can see that most of the drive voltage is lost with 100 mA of current and 500 feet of 22 AWG twisted pair transmission line, including the losses at the source resistor. The decoder in most IED's may very likely not detect the signal at 0.92 Vpp. Remember to make your cable runs as short as possible, to use a larger diameter cable, and to carefully distribute the loads. For example, the resistance for 18 AWG (bare, enamel-coated) copper wire is 6.38 ohms per 1000 feet.

8.4.7 Voltage Matching for Modulated IRIG-B

With modulated IRIG-B, it was mentioned that certain decoders are very intolerant of drive voltage variation. If the IED specification says that the acceptable voltage range is 3.3 Vpp +/- 0.5 volt, and the available voltage is high, then you must reduce the voltage using a dropping resistor. The value of the dropping resistor is determined by dividing the difference voltage by the device current. For example, suppose that the available voltage is 4.5 Vpp, the (nominal) acceptable voltage is 3.3 Vpp, and the device current is 10 mA. Determine the dropping resistor value (shown in 8.4).

$$(8.4) \quad R \text{ drop} = V \text{ difference} / I \text{ device} = (4.5 - 3.3) / 0.01 = 120 \text{ Ohms}$$

The Power dissipation (P) is calculated in 8.5.

$$(8.5) \quad P = I^2 R = (0.01)^2 (120) = 0.012 \text{ Watts}$$

An eighth-watt resistor should work fine.

For a voltage that is too low, then the modulated IRIG-B signal level must be increased by some other means, such as (1) distributing the load differently to reduce the current (raising the available voltage), (2) increase the wire size, or (3) by using a distribution amplifier.

8.4.8 Cable Delays

Electromagnetic waves travel at the speed of light (C) in free space or vacuum and a fraction of that through cabling. The speed of an electromagnetic wave in free space is given by Constant 8.6.

$$(8.6) \quad C \approx 9.84(10^8) \text{ feet/second}$$

Since electromagnetic waves travel slower through any cable, cable manufacturers normally specify cable with a velocity factor (VF), which is a percentage of the speed of light in free space, and characteristic of the specific cable. The Velocity Factor for the RG-6 cabling used by Arbiter Systems for GPS antenna connections, is about 83% of C. Most transmission lines have velocity factors in the range of 65% to 97%. Using these values you can determine the actual time delay in your cable distribution system and compare it to your required accuracy. As an example, it would

take 840 feet of RG-6 cable (with a velocity factor of 83%) to delay the signal by one microsecond. For IRIG-B timing applications, these delays may not be important, compared to other criteria. Otherwise, you would be forced to compensate for the time delay using another method, such as advancing the timing output or placing another master clock at the remote site.

8.4.9 Solutions

There are many solutions to providing an accurate timing signal in distant locations. However, the most satisfying solution may not be to string cabling for hundreds of meters. The costs associated with installing and maintaining cabling over a wide area may be unsatisfactory. Since the GPS is so pervasive, it may prove to be less costly to install another clock at a distant location, which would also improve accuracy and provide redundancy. Before installing cabling over a wide area, be sure to first examine all the possibilities.

Chapter 9

Relay Contacts and Event Inputs

9.1 Introduction to Relay Operation

The Model 1094B has one set of mechanical, Form C relay contacts that may be configured to switch with a predetermined fault, an out-of-lock condition, or driven by the programmable pulse feature. When configuring the 1094B relay contacts for programmable pulse, take care to compare the pulse rate with the life expectancy of the contacts. See Programmable Pulse in the Index for details on configuring the Model 1094B for programmable pulse.

9.2 Configuring

To configure these contacts, you will need to remove the cover to the clock chassis locate jumper JMP8. It is located just slightly left of center. See Section 5.3 for more information on configuring these jumpers.

9.3 Fault Conditions

If the FAULT LED illuminates, the clock status message will change to read:

CLOCK STATUS

ERROR {*message*}

Where *message* = one of the error messages listed below.

1. Receiver Failure (no communication between clock and GPS Receiver)
2. Antenna Short (antenna voltage is very low; it is normally 5 Vdc)
3. Antenna Open (antenna not drawing any current)

9.4 Viewing the Fault Status

If the Model 1094B executes a fault due to one of the conditions listed above, it will display the Clock Status fault condition on the LCD and illuminate the Fault LED. The fault status will also be available using the Event Status commands through either of the serial communications ports. See Section 10.3.4, Serial Communication and Command Set, for details on using the serial port to configure and access the event information.

9.5 Connecting to the Multimode Relay

When connecting the 1094B multimode relay, do not exceed the ratings and specifications. Figure 9.1 below illustrates the 5-mm spaced terminals on the connector plug for fastening wiring. Normal procedure is to strip the wire by one-fourth inch or more; DO NOT tin with solder prior to attaching to the connector plug. Tighten the set screw clockwise to secure wires.

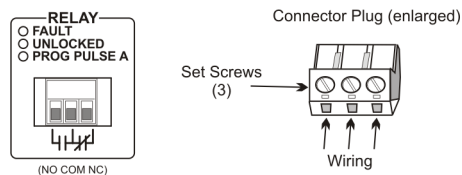

Figure 9.1: Rear Panel Relay Contact location and Connector Plug

9.5.1 Relay Contact Operation

The information below gives the contact condition for two states: (1) Fault, or Power OFF and, (2) No Fault. Silkscreen in Figure 9.1 indicates a Faulted or Power OFF condition.

- Fault, or Power Off – Left to Center pin open (NO), Center to Right pin shorted (NC).
- No Fault and Power On – Left to Center pin shorted, Center to Right pin open.

9.6 Introduction to Event Inputs

This section should provide more detail on the operation of the event inputs on the 1094B. To configure the event capture settings, see Section 5.5, Configuring Event Input Jumpers, and Section 7.12, Set Event/Deviation.

9.7 Event Timing Inputs

The Model 1094B provides one dual-function event input channel with 1-microsecond resolution at three possible input connectors: dedicated event input connector, COM1 or COM2. The event input channel may be used to time an input signal or continuously measure the 1-PPS deviation.

Data for individual recorded events can be recalled using either the Event/Deviation front panel key or via the RS-232C interface (see Section 10.3.5). Data for each event will be retained until it is retrieved using one of these two methods. Thus, if no event data points are retrieved or broadcast, recording will be suspended when the total number of events reaches 300. As soon as data is retrieved for a recorded event, its address (001 to 300) is made available for data corresponding to a new incoming event.

9.7.1 Event Timing – Latency

Event data are recorded using a high-speed capture circuit operating with a 96 MHz time-base. Latency is limited by the interrupt processing speed of the clock's microcontroller, which in turn depends on its workload at the time the event is received. Since the workload varies from time

to time, latency likewise varies. However, response time will, in general, never be less than a few hundred microseconds nor greater than 10 milliseconds.

9.7.2 Deviation Measurement

The event input can also be configured to display measured event times as 1 pulse-per-second (1 PPS) deviation measurements. The intended purpose of the deviation measurement function is to allow comparison of an external 1-PPS signal to the clock's precision internal 1-PPS signal. The clock determines the mean time difference between the two signals, which can be displayed on the front panel or collected through either COM1 or COM2.

9.7.3 Measurement Principle

The measurement technique employed for 1-PPS Deviation uses the same time determination and recording scheme used for Event Time measurement (refer to paragraph above), but makes the assumption that the input signal is periodic and continuous. Also, the operation of the circular memory buffer is modified somewhat, in that recording does not stop after the first 300 events; new event data is given priority over existing data, and will overwrite it. Since the incoming signal is at 1 Hz and the circular buffer holds 300 events, each event time record will be overwritten once every 300 seconds.

Once every second the processor looks at the most recent group of 16 events. To compute deviation, it uses only the portion of the event data describing fractional seconds (e.g. values between 0.0000000 and 0.9999999). The 16 fractional-second values are normalized around 0.0000000, so that the range of results from the deviation computations will be centered on zero (± 0.5 seconds). It also computes the statistical Mean and Sigma (Standard Deviation) values on the 16 values, which are then be displayed on the front panel or output via either COM1 or COM2.

9.7.4 Event Timer Input Channel Configuration

Adjustments to both the hardware and firmware configuration are required for the Model 1094B to receive input signals and to record events. The hardware configuration is described in Section 5.5, where jumpers JMP2 and JMP3 are identified. Discussion of the configuration through firmware follows in this section and in Section 10.3.5.

9.7.5 Configuring Event/Deviation Operation

There are two methods for configuring the Model 1094B for either event recording or 1 PPS deviation measurement: (1) through the front panel interface, and (2) through COM1 or COM2 RS-232 serial ports.

Configuring Event/Deviation Mode from Front Panel Interface

Press the SETUP key repeatedly until you reach the menu item that states:

SET EVENT/DEVIATION?

Press ENTER and the display should read,

```

EVENT OR DEVIATION?
EVENT SELECTED

```

The second line may also display “DEVIATION”. Press the UP or DOWN key to change to the desired mode and press the ENTER key.

Configuring Event/Deviation Mode from COM1 or COM2

Use the m,nEV command to configure the Event/Deviation function to either event recording or 1 PPS deviation measurement. For example, “0ev” configures the 1094B to the Event Mode, and “1ev” configures the 1094B to the Deviation Mode. For command reference, see Section 10.3.5.

9.7.6 Accessing or Displaying Event Data

Displaying Data on the Front Panel

Event and Deviation data can be accessed from either the front panel, COM1 or COM2. The following paragraphs describe the steps required to access data using the front panel EVENT/DEVIATION key. When pressing the EVENT/DEVIATION key, the display will enter a circular scroll, which begins by showing the data if any is present. The readout will display one of the event times (001 to 300), using the following format:

```

EVENT nnn
ddd:hh:mm:ss.ssssss

```

Where:

```

"nnn" = event number (001 to 300)
"ddd" = day of year of the event (1 to 366)
"hh" = hour of the event (00 to 23)
"mm" = minute of the event (00 to 59)
"ss.ssssss" = second and fractional seconds of the event

```

Press the UP or DOWN key to scroll the display through all events presently stored in the event time buffer. When you exit and then re-enter the event display mode, it will display the same event record number as when you exited. However, the data itself may be changed if it has been overwritten. Note that viewing an event on the front panel marks its position as available to be overwritten up to the event currently being viewed, but not after.

Accessing Data From COM1 or COM2

Access individual event data through COM1 or COM2 using the two serial commands, nED or EV. Use nED, with n = 1 – 300, to view a specific event by number. For example, type “29ed” to view event number 029. Type “198ed” to view event number 198. Use EV repeatedly to scroll up through the event buffer beginning at record 001. For example, type “ev”, “ev” and you will see record 001 and 002. If you send “ev” later, it will begin at record 003. Full details on these commands are located in Section 10.3.5.

Setting Event Channel Time

Set the event recording time to either UTC or Local by using the nTA command. For example, “0ta” sets the event time to UTC, and “1ta” sets the event time to Local.

Status of Event or Deviation

Use the SA command to determine the status of these functions. If you have configured the 1094B for event mode, send “sa” to return the read (R) and write (S) pointers. This tells you the current state of reading and writing in the event buffer. For example, typing “sa” returns the following response:

```
E R=004 S=026
```

This tells you that (1) the 1094B is set for Event recording, (2) the current “read” pointer is at event record 004 (when using the EV command), and (3) that there have been 26 records written to the event buffer. The “R” value (read index) does not automatically update on the display while events are being recorded.

9.7.7 Clearing Events

There are two ways to clear events from the Model 1094B event buffer: (1) through the front panel keys, and (2) through either COM1 or COM2 RS-232 connections. “Clearing” means to completely remove all 300 records at one time. This is different than viewing data on the display or viewing data through COM1 or COM2, which actually “marks” the individual event as having been “read” and may be overwritten with any new data. New events may only be overwritten if you view them sequentially, counting from Event 001.

Viewing individual event data on the front LCD panel, or through either COM1 or COM2, marks them as available to be overwritten. For example, if you look at records 1 – 10, and events are occurring while viewing these records, they will be overwritten. Assuming the event buffer is full, and you are viewing data from records 15 – 20 through COM1 or COM2, events will not be overwritten until you also view records 1 – 14. Viewing events includes retrieving event records over COM1 or COM2.

Clearing Events from the Front Panel

To clear all recorded events stored in the event storage buffer, press the SETUP key until you reach the menu that says,

```
SET EVENT/DEVIATION?
```

Press ENTER and the display should read,

```
SET EVENT/DEVIATION?  
EVENT SELECTED
```

Press ENTER and the display should read

CLEAR EVENT DATA?
YES:UP NO:DOWN

Clearing Events Using Serial Commands

Type or send “0,123ev” or “1,123ev” to immediately clear all events stored in the event buffer. See Section 10.3.5.

Clearing Events Using the 1094 Utility

Using the 1094 Utility, first connect to the Model 1094B and select Unit > Clear Events, or click the Clear Events button. See Section 6.6.4.

Chapter 10

Serial Communication and Commands

10.1 Introduction

The Model 1094B has two RS-232/485 ports, called COM1 and COM2. COM1 combines the two functions of RS-232 and RS-485 at one DB9M connector (J5), and COM2 combines the two functions of RS-232 and RS-485 in a separate DB9M connector (J7). The RS-232 ports do not use flow control, and the RS-485 ports function in transmit only mode.

Use the two serial ports interchangeably for separate functions. You may wish to interrogate the clock on one port for basic information (i.e to configure something) and at the same time be able to have the second serial port broadcasting a specific time code to a meter. While most recent substation equipment has standardized on the IRIG-B time code, some devices are designed to receive ASCII data through the serial port. Another common serial-port function is to connect a digital wall display to indicate the time.

10.2 Communication Port Information

Table 10.1 lists functions and associated pins for both the RS-232 and RS-485 ports.

Pin No.	Function	Pin No.	Function
1	Not Connected	6	RS-232 Input
2	RS-232, Rx Data	7	Not Connected
3	RS-232, Tx Data	8	RS-422/485, Tx-A
4	RS-232 Output/Prog Pulse	9	RS-422/485, Tx-B
5	Ground	–	–

Table 10.1: COM1 and COM2 Pin Definitions

10.3 Command Set

This section provides information for controlling and communicating with the Model 1094B via the RS-232C serial interface. All of the RS-232 commands are functionally grouped into similar categories. For example, Section 10.3.11 lists all of the commands used to both set and retrieve the date and time in one of the standard formats.

Each command name and syntax is highlighted in bold at the first line of each definition. Detailed information used to interpret the commands and responses follows each command heading. Sometimes the command is very short, such as the command to return the Local Time: TL. Other commands require a prefix before the letter command to specify them, such as to broadcast: m,n,o,pBR. For example, the command to start the ASCII Standard broadcast string at a rate of once per second, on Local time, from COM1 is 1,1,1,0BR.

When a command requests information from the 1094B, it returns the most current data available. Numeric data is returned as an ASCII string of numeric characters, with leading sign and embedded decimal point as needed. Strings are terminated with carriage return and line feed characters. Enter any RS-232C command as written in these tables *without* pressing ENTER. Characters are automatically entered when typed. If including any of these commands in a programming sequence, do not include any carriage-return or line-feed characters.

The following symbols and syntax are used throughout and are repeated here for emphasis:

- ␣ = Shorthand for carriage-return, line-feed
- U = UTC Time
- L = Local Time
- soh = An ASCII character (start of header) = Hex 01
- bel = An ASCII character = Hex 07
- n = integer used for various numerical values (e.g. nnn in minutes)
- yyyy = four digit year
- ddd = Julian day-of-year
- mm = month
- hh = hour
- mm = minute
- ss = second

Underlines are used for clarity only and graphically represents the location of ASCII spaces.

10.3.1 Configuring Custom Broadcast Strings

The Model 1094B has two custom strings (A and B) available for you to configure. Use the @@A... or @@B... to define and install the new string. Three elements are available for building up a custom string: characters, true/false conditions and ordinal conditions. Table 10.2 lists all of the available characters for you to build up your special string. True/False condition statements provide some logic in the output. Ordinals enables you to view levels of measurement based on the command statements; for example you might want to indicate a level of accuracy in the string. Examples follow to illustrate how some of the standard strings look using the characters in Table 10.2, true/false statements and ordinal statements.

Custom String Command

Command: @@A . . . , @@B . . .

Use @@A . . . to create a Channel A broadcast, and @@B . . . to create a Channel B broadcast string. This includes start of header (Hex 01), time, date, carriage-return, and other required features. In a sense, it allows you to create a custom broadcast string. These characters and definitions are listed in Table 10.2 below, along with custom string examples.

Custom Broadcast Characters

Character	Meaning
//	/ character
/C:ssnn	Xor checksum of specified range, where ss = start location (hex value from 00 to FF) and nn = number of bytes (hex value from 00 to FF)
D	Day of month (1, . . . , 31)
d	Day of year (001, . . . , 366)
e	GPS elevation (\pm dddddd.dd length = 10)
f	Fractional Seconds (00, . . . , 99)
/H:xx	Hexadecimal value where xx is a hex value from 00, . . . , FF
h	Hour (00, . . . , 23)
m	Minute (00, . . . , 59)
M	Month (1, . . . , 12)
O	Local hour offset (\pm hh where hh=0, . . . , 12)
o	Local minute offset (0, . . . , 59 minutes)
Pi	Latitude where i = 1, degrees (dd); = 2, Minutes (mm); = 3, Fractional minutes (mmmm); = 4, Seconds (ss); = 5, Fractional seconds (fff); = 6, N (North) or S (South)
pi	Longitude where i = 1, Degree (ddd); = 2, Minutes (mm); = 3, Fractional minutes (mmmm); = 4, Seconds (ss); = 5, Fractional seconds (fff); = 6, E (East) or W (West)
r	Carriage return and line feed
Sii	String Type where ii: 01 = Status change (receiver out of lock, antenna short, antenna open)
s	Seconds (00, . . . , 59)
Txx	On time character where xx is a hex value from 01 to FF (Note: Must be at the start or end of the string!)
U	Unlock time (00, . . . ,99 minutes)
W	Day of week (1, . . . , 7 where 1 = Sunday)
w	Day of week (1, . . . , 7 where 1 = Monday)
y	Year (00, . . . , 99)
Y	Year (2000, . . . , 2xxx)

Table 10.2: Custom String Character Table

Table 10.2 Notes Conditionals can use any of the above, with the exception of /C_{ssnn} and T_{xx}, in addition to any string characters. CONDITIONALS CANNOT BE NESTED!

True/False Condition

Command: /*[ii? < t > / :< f > /]*

where:

< t > = True condition

< f > = False condition

ii: 01 = Locked; 02 = Status change; 03 = Locked with max accuracy; 04 = Fault; 05 = Daylight Saving Time change pending

Ordinal Condition

Command: /*{ii? < 0 > / :, ..., < n > / ; < e > }*

where:

< 0 >, < 1 >, ..., < n > = ordinal position

< e > = Else condition

ii: 01 = Time Quality (13 possible ordinals); 02 = Time Zone Indicator (3 possible, 0=DST active, 1=Not active, 2=UTC)

String Setup Examples

The examples listed below illustrate how various strings are specified using the @@**A** ... or @@**B** ... commands. In order to create your own custom string, you will need to type in characters from Table 10.2, including any conditionals (as noted above) immediately after @@**A** or @@**B**. The example command below shows how to configure COM1 with the ASCII Standard broadcast from the 1094B using a terminal window.

Sample Command for ASCII Standard: @@A/T01/d:/h:/m:/s/r

Standard Broadcast Strings

Interrogate Broadcast off:

ASCII Standard: /T01/d:/h:/m:/s/r

Vorne Standard: 44/h/m/s/r55/d/r11/U/r/T07

Status: /[02?/d:/h:/m:/s /S01/r:/]

Ext. ASCII (DTSS MSG): /T0D/H0A/[03? /:~/]/y /d:/h:/m:/s.000

ASCII + Quality: /T01/d:/h:/m:/s/{01? /:./:*/:#/;/?}/r

ASCII + Year: /T01/Y /d:/h:/m:/s/{01? /:./:*/:#/;/?}/r

Return Custom String – mCB

To return a custom string installed in the Model 1094B, use the mCB command, where m = 0 for Custom 1 and m = 1 for Custom 2.

10.3.2 Broadcast Mode Overview

Command Explanation

Broadcast strings are controlled by using the command **m,n,o,pBR**, where m = 0 to 16, and includes the following broadcast messages:

0, INTERROGATE MODE	9, NMEA183ZDA
1, ASCII STD	10, ABB_SPA_MSG
2, VORNE STD	11, DISPLAY_BUFFER
3, EVENT DATA	12, PATEK PHILIPPE MSG
4, STATUS	13, KISSIMMEE MSG
5, EXT. ASCII	14, NGTS
6, ASCII + QUAL	15, CUSTOM 1
7, YEAR + ASCII	16, CUSTOM 2
8, NMEA183GLL	

n = the update rate, from 0 to 9999 seconds; o = the Time Zone, where 0 = UTC and 1 = Local;
p = the COM port, where 0 = COM1 and 1 = COM2

Broadcast Example

Set the 1094B to broadcast the Vorne Std output at a rate of once per second, in Local time from COM1.

Send: **2,1,1,0BR**

To turn off a broadcast, Send: **0BR**, for COM1, or **1BR**, for COM2.

Returned Settings

After sending certain commands to configure the Model 1094B, the clock will return the new settings to the computer or terminal. For example after sending 2,1,1,0BR, the clock will return the following:

Returned: **m:02 n:0001 o:01 p:00**

10.3.3 COM Port Settings

Set COM Port Settings

Command: **2,b,w,s,p,cYB**

Sets the COM port settings as follows:

b = baud rate: 0 = 1200, 1 = 2400, 2 = 9600, 3 = 19200, 4 = 38400; w = word length: 0 = 7 bits, 1 = 8 bits; s = stop bits: 0 = 1 bit, 1 = 2 bits; p = parity: 0 = off, 1 = even, 2 = odd; c = COM port: 0 = COM1, 1 = COM2.

10.3.4 Broadcast Commands

Broadcast Mode – INTERROGATE (OFF)

Command: **0BR, 1BR**

0BR deactivates the RS-232C Broadcast Mode (resets to Interrogate Mode) on COM1. 1BR deactivates the RS-232C Broadcast Mode on COM2. m,n and o are not necessary to turn off the broadcast from either COM port.

Response: >

Broadcast Mode – ASCII STD

Command: **1,n,o,0BR, 1,n,o,1BR**

1,n,o,0BR configures the 1094B to broadcast the time-of-day as ASCII standard data on COM1. 1,n,o,1BR configures the 1094B to broadcast ASCII standard data on COM2. Set n equal to the desired broadcast interval (in seconds) and o according to the desired time zone (UTC or Local), where o = 0 for UTC and o = 1 for Local.

Response: <soh>ddd:hh:mm:ss >

Broadcast Mode – VORNE STD

Command: **2,n,o,0BR, 2,n,o,1BR**

2,n,o,0BR configures the 1094B to broadcast from COM1 data formatted for Vorne large format time displays. Refer to Arbiter Systems Application Note 103 for more information. 2,n,o,1BR configures the 1094B to broadcast Vorne-formatted data on COM2. Set n equal to your desired broadcast interval (in seconds) and o according to the desired time zone (UTC or Local).

Response:

```
44hhmmss >(UTC/Local Time)
55ddd >(day of year)
11nn >(out-of-lock time)
bel (bel = Hex 07; sounds at the end of the time code)
```

Response (broadcast interval depends on n; the number and order of strings returned depend upon options ordered with clock, for example Option 28):

Data is transmitted ahead of time, and the bel character is transmitted on time. When properly configured, the Vorne displays update simultaneously upon receipt of the bel character.

Broadcast Mode – EVENT DATA

Command: **3,n,o,0BR, 3,n,o,1BR**

3,n,o,0BR configures the 1094B to broadcast from COM1 any event data at the time it is recorded. 3,n,o,1BR configures the 1094B to broadcast from COM2 any event data at the time it is recorded. n is ignored and o determines whether the event time is either UTC (o=0) or Local (o=1).

Response:

```
Local mm/dd/yyyy hh:mm:ss.ssssss nnnL >
UTC mm/dd/yyyy hh:mm:ss.ssssss nnnU >
```

Where:

```
nnn = Event-Buffer Read Index Number
U = UTC Time
L = Local Time
```

Broadcast Mode – STATUS

Command: **4,n,o,0BR**, **4,n,o,1BR**

4,n,o,0BR configures the 1094B to broadcast any status data from COM1 when it changes. 4,n,o,1BR configures the 1094B to broadcast any status data from COM2 when it changes. n and o are ignored. NOTE: When a valid fault is detected, the specific status fault is broadcast (with Julian day, and time) to the chosen serial port once. When the fault clears, another message is sent describing the cleared fault.

Response with fault:

```
ddd:hh:mm:ss OUT OF LOCK >
```

Other messages: “ANTENNA OPEN” or “ANTENNA SHORT” or “RECEIVER FAILURE”

Response when fault clears:

```
ddd:hh:mm:ss LOCKED >
```

Other messages: “ANTENNA OK”, “RECEIVER OK”

Broadcast Mode – EXT. ASCII

Command: **5,n,o,0BR**, **5,n,o,1BR**

EXT. ASCII (or Extended ASCII) and adds a time quality indicator to the end of the Standard ASCII time string. 5,n,o,0BR configures the 1094B to broadcast from COM1 the time-of-day as ASCII using an extended format prefaced with a time quality indicator (Q). 5,n,o,1BR configures the 1094B to broadcast the same data from COM2. The start bit of a carriage-return is transmitted on time. Set n equal to your desired broadcast interval (in seconds), o according to the desired time zone (0 = UTC, or 1 = Local).

Response:

```
> Q-yy_ddd_hh:mm:ss.000_--
```

Format:

> = Carriage-return, line-feed.

Q = Time quality indicator, and may be represented by:
(a space) = meaning it is locked with maximum accuracy.

? = (ASCII 63) unlocked, accuracy not guaranteed

_ = used for clarity only and graphically represents the location of ASCII spaces.

Broadcast Mode – ASCII + QUAL

Command: **6,n,o,0BR, 6,n,o,1BR**

ASCII + QUAL means Standard ASCII plus Time Quality Indicator. 6,n,o,0BR configures the 1094B to broadcast from COM1 the time-of-day as ASCII data appended with a time quality indicator. 6,n,o,1BR configures the 1094B to broadcast from COM2. Set n equal to your desired broadcast interval (in seconds) and o according to the desired time zone (0 = UTC or 1 = Local).

Response:

<soh>ddd:hh:mm:ssQ >

Format:

soh = Hex 01 – the start bit of the soh character is transmitted on time.

Q = Time quality indicator. may be represented by:

space = locked, maximum accuracy

. = (ASCII 46) Error < 1 microsecond

* = (ASCII 42) Error < 10 microseconds

= (ASCII 35) Error < 100 microseconds

? = (ASCII 63) Error > 100 microseconds

Broadcast Mode – YEAR + ASCII

Command: **7,n,o,0BR, 7,n,o,1BR**

YEAR + ASCII is the same as ASCII plus Time Quality Indicator adding the four-digit year to the beginning of the string. 7,n,o,0BR configures the 1094B to broadcast from COM1 the year and time-of-day as ASCII data appended with a time quality indicator. 7,n,o,1BR configures the 1094B to broadcast from COM2. Set n equal to your desired broadcast interval (in seconds) and o according to the desired time zone (0 = UTC or 1 = Local).

Response:

<soh>yyyy:ddd:hh:mm:ssQ >

Format:

soh = Hex 01 – the start bit of the soh character is transmitted on time.

Q = Time quality indicator. may be represented by:

space = locked, maximum accuracy

. = (ASCII 46) Error < 1 microsecond

* = (ASCII 42) Error < 10 microseconds

= (ASCII 35) Error < 100 microseconds

? = (ASCII 63) Error > 100 microseconds

Broadcast mode - NMEA183GLL

Command: **8,n,o,0BR, 8,n,o,1BR**

8,n,o,0BR configures the 1094B to broadcast the National Marine Electronics Association Standard (NMEA - 0183) to broadcast from COM1. 8,n,o,1BR configures the 1094B to broadcast the same

standard from COM2. Set n equal to your desired broadcast interval (in seconds) and o according to the desired time zone (0 = UTC or 1 = Local).

GLL - Geographic Position, Latitude-Longitude

Latitude and Longitude of present vessel position, time of position fix and status.

Response:

```
$-GLL,llll.llll,a,yyyyy.yyyy,a,hhmmss.sss,A >
```

Where:

GLL = Geographic Position, Latitude / Longitude

llll.llll = Latitude of position

a = N or S

yyyyy.yyyy = Longitude of position

a = E or W

hhmmss.sss = UTC of position

A = status: A = valid data

Broadcast Mode - NMEA183ZDA

Command: **9,n,o,0BR, 9,n,o,1BR**

9,n,o,0BR configures the 1094B to broadcast the National Marine Electronics Association Standard (NMEA - 0183) to broadcast from COM1. 9,n,o,1BR configures the 1094B to broadcast the standard from COM2. Set n equal to your desired broadcast interval (in seconds) and o according to the desired time zone (UTC or Local).

ZDA - Time & Date

UTC, day, month, year, and local time zone.

Format: `$-ZDA,hhmmss.ss,dd,mm,yyyy,xx,xx >`

Where:

ZDA = Time and date

hhmmss.ss = Time in UTC

dd = Day, 01 to 31

mm = Month, 01 to 12

yyyy = Year

xx = Local zone description, 00 to +/- 13 hours

xx = Local zone minutes description (same sign as hours)

Broadcast Data – ABB_SPA_MSG

Command: **10,n,o,0BR, 10,n,o,1BR**

10,n,o,0BR configures the 1094B to broadcast the ABB SPA format from COM1. 10,n,o,1BR configures the 1094B to broadcast the same format from COM2. Set n equal to your desired broadcast interval (in seconds) and o according to the desired time zone (0 = UTC or 1 = Local).

The ABB SPA Time String is a sequence of 32 ASCII characters starting with the characters >900WD and ending with the Carriage Return character. The letters printed in Italics are replaced

by ASCII numbers whereas the other characters are part of the time string. The groups of characters as defined below:

Response:

```
>900WD:yy-mm-dd_hh:mm:ss.fff:cc ␣
yy-mm-dd = the current date:
yy = year of century, (00..99)
mm = month, (1..12)
dd = day of month, (01..31)
_ = Space (ASCII code 20H)
hh:mm:ss.fff = the current time
hh = hours, (00..23)
mm = minutes, (00..59)
ss = seconds, (00..59, or 60 while leap second)
fff = milliseconds, (000..999)
cc = Check sum*
␣ = Carriage Return (ASCII code 0Dh)
```

*EXCLUSIVE-OR result of previous characters, displayed as HEX byte (2 ASCII characters 0..9 or A..F)

Broadcast DISPLAY SCREEN

Command: **11,n,o,0BR, 11,n,o,1BR**

11,n,o,0BR configures the the 1094B to broadcast the Display Buffer (information as currently viewed on the front-panel display) from the COM1. 11,n,o,1BR configures the 1094B to broadcast the Display Buffer from COM2. Set, n equal to your desired broadcast interval (in seconds) and o according to the desired time zone (0 = UTC or 1 = Local).

Broadcast PATEK PHILIPPE MSG

Command: **12,n,o,0BR, 12,n,o,1BR**

12,n,o,0BR configures the 1094B to broadcast the Patek Philippe Message (or CUSTOM 1) from COM1. 12,n,o,1BR configures the 1094B to broadcast the Patek Philippe Message from COM2. Set n equal to your desired broadcast interval (in seconds) and o according to the desired time zone (0 = UTC or 1 = Local).

Response: T:yy:mm:dd:dw:hh.mm:ss ␣

Where: dw = day of week

Broadcast KISSIMMEE_MSG

Command: **13,n,o,0BR, 13,n,o,1BR**

13,n,o,0BR configures the 1094B to broadcast the Kissimmee Message (or Custom 2) from COM1. 13,n,o,1BR configures the 1094B to broadcast the Kissimmee Message from COM2. Set n equal to your desired broadcast interval (in seconds) and o according to the desired time zone (0 = UTC or 1 = Local).

Response:

ddd:hh.mm:ssQ<LF><CR>

Where:

Q = quality indicator (with indicators shown below)

_ = locked, maximum accuracy

. = (ASCII 46) Error < 1 microsecond

* = (ASCII 42) Error < 10 microseconds

= (ASCII 35) Error < 100 microseconds

? = (ASCII 63) Error > 100 microseconds

Broadcast NGTS

Command: **14,60,o,0BR, 14,60,o,1BR**

14,60,o,0BR configures the 1094B to broadcast the NGTS Message from COM1. 14,60,o,1BR configures the 1094B to broadcast the NGTS Message from COM2. Set n equal to your desired broadcast interval (in seconds, normally set to 60, or once per minute) and o according to the desired time zone (0 = UTC or 1 = Local). Note that in Table 10.3, “BST” refers to British Standard Time, and “GMT” refers to Greenwich Mean Time now obsolete and essentially the same as UTC.

Response: TyymmmdmDhhmmGVcc >

Example: T0206252191701 >

Example response meaning: seven seventeen pm on Tuesday the 25th June 2002, in local time and true time-valid character.

Description	No. of Characters	Character Pos.	Range
Code ID (T)	1	1	Capital T
Year in Century (yy)	2	2,3	0-99 (02=2002)
Month (mm)	2	4,5	0-12
Day of Month (dm)	2	6,7	01-31
Day of Week (D)	1	8	1-7 (1=Mon.)
Hours (hh)	2	9,10	00-23
Minutes (mm)	2	11,12	00-59
GMT Marker (G)	1	13	0=BST, 1=GMT
Validity Marker (V)	1	14	0=Non Valid, 1=Valid
CRLF (cc)	2	-	cc: Non-Printing, Control

Table 10.3: NGTS Data Message Content

10.3.5 Event Mode Commands

Return Specific Event

Command: **nED**

nED sets the event buffer Read Index to a specific event number (1 to 300), and returns that event information in either Local or UTC time format depending on how the command, nTA is configured.

Response:

LCL mm/dd/yyyy hh:mm:ss.ssssss nnnL ⤵

UTC mm/dd/yyyy hh:mm:ss.ssssss nnnU ⤵

Format:

n = Event-Buffer Read Index Number

U = UTC Time

L = Local Time

Set Event Channel Time

Command: **nTA**

Sets the time source as either Local or UTC, where n = 0 sets the event time to UTC and n = 1 sets the event time to Local.

Control Event Operation

Command: **m,nEV, EV**

m,nEV controls event operation, where m = 0 sets the Event mode, and m = 1 sets the 1-PPS Time Deviation mode. Use n = 0 for commands, except that n = 123 clears the event buffer. EV returns a single event from the Channel A event buffer.

For example: 0,0ev sets the Event Mode; 1,0ev sets the 1-PPS Deviation Mode; 0,123ev clears the event data.

Response: ⤵

Return Deviation for Event Channel

Command: **DA**

Returns 1-PPS deviation and sigma for the event input.

Response:

± dddd.dd ssss.ss ⤵ (Results are in microseconds)

Format:

dddd.dd = the deviation from 1 PPS (GPS), averaged over 16 samples

ssss.ss = the standard deviation (sigma) of samples

10.3.6 Status Mode Commands

Status of Event/Deviation

Command: **SA**

SA returns the event/deviation Channel setup information, read index number and write index number.

Response:

D/E, R = nnn, S = mmm >

Format:

D indicates the input channel is in 1 PPS deviation mode

E indicates the input channel is in Event Mode

nnn Channel read index (000 to 299)

mmm Channel write index (000 to 299)

NOTE: When nnn = mmm, and when using the EA command to read event data, the event buffer is empty, i.e., all event data which has been recorded has also been read.

Clock Status

Command: **SC**

SC returns the current clock status.

Response:

L/U, U=xx, S=nn >

Format:

L = Clock currently locked to GPS (U for unlocked).

xx = Indicates loss of lock period, up to 99 minutes.

nn = User specified out-of-lock delay, 00 to 99 minutes (refer to Table A-8).

S = Off if the out-of-lock function is deactivated, S = ZDL indicates zero delay.

EEPROM Status

Command: **SE**

SE returns the EEPROM status. T = Timeout Errors; CE = Corrected Errors.

Response:

T=t CE=ee

Format:

t = 0, No Timeout Error; t = 1, Timeout Error

ee = Number of corrected errors in reading EEPROM data

Receiver Status

Command: **SR**

SR returns the current receiver status.

Response:

V=vv S=ss T=t P=Off E=0 >

Format:

vv = Number of satellites, visible to the antenna, per almanac.
 ss = relative signal strength (range: 0 to 255, nominal value = 15)
 t = Number of satellites being actively tracked (up to twelve)
 P = Off, Indicates that the time dilution of precision (TDOP) calculation is not being performed. Returns 1.0 - 99.0, depending on satellite geometry, when TDOP calculation is being performed. A TDOP calculation is NOT performed if less than 3 satellites are visible, OR if Position-Hold is active. E = 0, currently unused

Time Quality

Command: **TQ**

Returns a single ASCII character (0, 4-9, A, B, F) indicating estimated worst-case time quality, which follows the IEEE Standard, P1344.

Response: h > (h = Condition; values shown below)

0 = Clock locked, maximum accuracy
 4 = Clock unlocked, accuracy < 1 us
 5 = Clock unlocked, accuracy < 10 us
 6 = Clock unlocked, accuracy < 100 us
 7 = Clock unlocked, accuracy < 1 ms
 8 = Clock unlocked, accuracy < 10 ms
 9 = Clock unlocked, accuracy < 100 ms
 A = Clock unlocked, accuracy < 1 s
 B = Clock unlocked, accuracy < 10 s
 F = Clock failure, time not reliable

10.3.7 Local / Daylight Saving Time Setup Commands

Set Daylight Saving/Summer Time Mode

Command: **1,mDT**

1,mDT activates the Daylight Saving Mode, where m = 0 to 2, with 0 = OFF, 1 = ON, and 2 = AUTO. When OFF this time adjust feature does not add the specified offset to local time display and output. With m = 1 (ON), the Daylight Saving / Summertime feature is always on. With m = 2, the Daylight Saving / Summertime feature will automatically change at the specified dates and times. To complete the Daylight Saving / Summer Time setup, you must also use the Set Daylight Saving Auto Start and Stop commands that follow below.

Return Daylight Saving/Summer Time Settings

Command: **0DT**

0DT returns the current Daylight Saving / Summer Time Settings to the current COM port.
Response: (Mode: OFF, ON, or AUTO)

```
Mode:AUTO >
START:02:00 Second SUN of MAR >
STOP :02:00 First SUN of NOV >
```

Set Daylight Saving/Summer Auto Start Time

Command: **2,w,x,y,zDT**

Sets the date and time when Daylight Saving / Summer Time starts.

Where,

```
w = Month (0 through 11), with 0 = Jan, 1 = Feb, ... 11 = Dec.
x = WeekOfMonth (0 through 5), with 0 = First, 1 = Second, 2 = Third,
    3 = Last, 4 = Second from Last, and 5 = Third from Last.
y = DayOfWeek (0 through 6), with 0 = Sun, 1 = Mon, ... , 6 = Sat.
z = Minutes after midnight z (0 through 1440).
```

Response: >

Set Daylight Saving/Summer

Command: **3,w,x,y,zDT**

Sets the date and time when Daylight Saving / Summer Time stops. Where,

```
w = Month (0 through 11), with 0 = Jan, 1 = Feb, ... 11 = Dec.
x = WeekOfMonth (0 through 5), with 0 = First, 1 = Second, 2 = Third,
    3 = Last, 4 = Second from Last, and 5 = Third from Last.
y = DayOfWeek (0 through 6), with 0 = Sun, 1 = Mon, ... , 6 = Sat.
z = Minutes after midnight z (0 through 1440).
```

Response: >

Local Offset Command

Command: **mLT**

mLT sets the local offset in minutes from -720 to +720 (-12 to +12 hours), where m equals the number of minutes, positive (East) or negative (West).

Response: >

10.3.8 Front Panel Control Commands

Front Panel and Backlight Control

Command: **m,nFP**

This command controls two actions; it enables or locks the keypad, and offers backlight control. m = 0 enables the keypad, and m = 1 locks the keypad. n = 0 turns OFF the backlight, n = 1 turns

ON the backlight, and $n = 2$ sets the backlight to the AUTO mode, where it automatically turns off after 30 seconds of inactivity.

Response: \succ

10.3.9 IRIG-B Data Output Commands

IRIG Data IEEE P1344

Command: **m,n,oIR**

This command controls the activity of the IRIG-B IEEE P1344 control bits.

Where:

$m = 0$, IRIG-B IEEE P1344 control bits OFF, $m = 1$, control bits ON,

$n = 0$, IRIG Time = UTC, $n = 1$, IRIG Time = Local

$o = 0$, IRIG Output on Main, $o = 1$, IRIG Output on Aux port (Prog. Pulse B).

Response: \succ

10.3.10 Position Data Commands

Return Elevation

Command: **LH**

Returns the current antenna elevation.

Response:

nnnnn.nn \succ (from -1000.00 to +18000.00 meters WGS-84)

Format:

Where:

Elevation in meters referenced to the WGS-84 datum

$n = -1000.00$ to $+18000.00$ meters.

Return Latitude

Command: **LA**

Returns the current antenna latitude.

Response:

Ndd:mm:ss.sss \succ

Format:

N = North (S for South)

dd = degrees

mm = minutes

ss.sss = seconds

Return LongitudeCommand: **LO**

Returns the current antenna longitude.

Response:

Wddd:mm:ss.sss >

Format: W = West (E for East)

ddd = degrees

mm = minutes

ss.sss = seconds

Set Receiver PositionCommand: **d,m,s,D,M,S,hSP**

Response: Sets the receiver position based on the following values: negative values are South latitude and West longitude, positive values are North latitude and East longitude.

d = degrees latitude, m = minutes latitude, s = seconds of latitude

D = degrees of longitude, M = minutes of longitude, S = seconds of longitude

h = height (\pm meters)**10.3.11 Date and Time Commands****Set Receiver Time**Command: **yyyy:mm:dd:hh:mmTS**

TS sets the receiver (UTC) time only when not locked to the GPS. The command is ignored when locked to satellites. When the receiver is initially activated, and has not locked onto satellites, acquisition time may be improved by giving the clock an initial estimate of UTC time, which it can use (with stored position and almanac data) to determine which satellites and Doppler shifts to use in acquisition.

Format: yyyy = year

mm = month

dd = day

mm = minute

hh = hour

Response: >

Return Local DateCommand: **DL**

DL returns the current date, in Local time.

Response: ddmmyyyy

Return UTC Date

Command: **DU**

DU returns the current date, in UTC time.

Response: ddmmmyyyy >

Return Local Time

Command: **TL**

TL returns the current Local time.

Response: ddd:hh:mm:ss >

Return UTC Time

Command: **TU**

TU returns current UTC time.

Response: ddd:hh:mm:ss >

NOTE: The DL, DU, TL and TU command formats are identified as follows:

Format: yyyy = year	dd = day of month
hh = hour	ss = second
mmm = month (JAN DEC)	ddd = day of year
mm = minute	

10.3.12 Programmable Pulse Output Commands**Set Pulse Width, Seconds-Per-Pulse**

Command: **m,nPW**

m,nPW configures the Programmable Pulse output pulse width in seconds. Where, m = 0 through 60,000 in 10 millisecond increments (gives you from 0 to 10 minutes). n = 0 for Output A (Timing Outputs 1 and 2), n = 1 for Output B (Timing Outputs 3 and 4).

Response: >

Set Programmable Pulse Output Mode

Command: **m,nPM**

m,nPM configures the programmable pulse mode and output port. Programmable Pulse A can go to Timing Outputs 1 and 2, Programmable Pulse B can go to Timing Outputs 3 and 4. Frequency Mode and Aux IRIG Mode only apply to Programmable Pulse B. m = 0, 1, 2 and 3; n = 0 and 1, where:

Mode m: m = 0 Pulse OFF; m = 1, Pulse Mode; m = 2, Frequency Mode; m = 3, Aux IRIG Mode. Mode n: n = 0, Timing Outputs 1 and 2; n = 1, Timing Outputs 3 and 4

Response: >

Set Alarm Time Mark

Command: **d,h,m,s,hs,oAL**

Sets the time at which the Model 1094B issues the programmable pulse. d, h, m, s and hs set the output pulse to be generated at the next occurrence of the specified time and date. o sets the output to either Programmable Pulse A (communication ports 1 and 2) and Programmable Pulse B (communication ports 3 and 4).

Format: d = day of year (1 through 366)

h = hour (0 through 23)

m = minute (0 through 59)

s = second (0 through 59)

hs = fractional seconds in 0.01 increments (00 through 99)

o = Programmable Pulse A or B; 0 = A, 1 = B

Response: >

Set Programmable Pulse-Mode Type

Command: **m,nPT**

m,nPT configures the programmable pulse mode type, where m = 0 through 6 are the types, and n = 0 for Prog. Pulse A and n = 1 for Prog. Pulse B. For programming details, see Section 7.9.

Mode m: m = 0, PULSE PER SECOND; m = 1, PULSE PER MINUTE; m = 2, PULSE PER HOUR; m = 3, PULSE PER DAY; m = 4, SINGLE TRIGGER; m = 5, SLOW CODE; m = 6, SECONDS PER PULSE

Response: >

Set Programmable Pulse Delay

Command: **m,nPD**

m,nPD sets the delay between pulses for Seconds-Per-Pulse mode, where m selects the number of seconds in 10 millisecond increments (up to 60,000 seconds, or 16 hours and 40 minutes); n = 0 selects Prog. Pulse A and n = 1 selects Prog. Pulse B. For example, to set Prog. Pulse A seconds-per-pulse mode for a pulse every 5 minutes (or 300 seconds), use the following command: 30000,0PD.

Response: >

Set Pulse Polarity

Command: **m,nPP**

m,nPP sets the programmable pulse output polarity (i.e. TTL/CMOS high or low). m = 0, positive and m = 1, negative; n = 0 and 1, with 0 = Prog. Pulse A and 1 = Prog. Pulse B.

Response: >

Set Output Frequency

Command: **mPF**

mPF sets the programmable pulse output frequency for Programmable Pulse B from 1 to 1000 pulses per second, where m = the frequency in pulses per second. Used with the Frequency Mode.

Response: >

Set Time Selection

Command: **m,nPS**

m,nPS sets the programmable pulse time selection to either UTC or Local, where m = 0 for UTC and m = 1 for Local, and n = 0 for Programmable Pulse A and n = 1 for Programmable Pulse B.

Response: >

10.3.13 Antenna System Delay Commands

Set Antenna Delay

Command: **nnnnnnDA**

Sets antenna system delay compensation value. NOTE: Factory default setting for the standard 15-meter (50-foot) cable is 60 ns. Time range is from 0 to 999999 nanoseconds. The exact syntax for a 60-ns delay is 60DA. See Section 4.4.1 for information on calculating cable delay.

Response: >

10.3.14 Out-of-Lock Commands

Set Out-of-Lock Time

Command: **(-)nLK**

(-)nLK configures the Out-Of-Lock function in the 1094B. A negative number turns the out-of-lock function OFF. n = 0 sets the out-of-lock time to zero delay. n = 1 to 99 sets the amount of delay time (in minutes) following loss of satellite synchronization before an out-of-lock signal is generated and the relay contacts close.

Response: >

10.3.15 Miscellaneous Commands

Return Firmware Version

Command: **VE**

Returns the Firmware Revision date of the installed ROM.

Response: dd mmm yyyy >

Set Survey Mode

Command: **mSS**

Sets the survey mode to either Turn Survey mode Off or for Power On Survey, where $m = 0$ for Turn Off Survey, $m = 1$ for Power On Survey. Use $m > 1$ to return survey mode.

Set Display Mode

Command: **mDM**

Sets the display mode to the following: for $m = 0$, enables the current status display; $m = 1, 2, 3$, and 4 enables the time displays; $m = 5, 6$, and 7, enables the position displays; $m = 8, 9$ and 10, enables status displays; $m = 11$ enables event/deviation display.

Return Display Buffer

Command: **DZ**

Returns the contents of Display Buffer.

Response: Echoes current display (40 characters). No line wrap.

Appendix A

Technical Specifications and Operating Parameters

A.1 Introduction

In this section you will find the limits of the functional and operational characteristics of the Model 1094B GPS Substation Clock. Topics include Receiver Characteristics, I/O Configuration, System Interfaces, Antenna System, Operator Interfaces, and Physical Specifications.

NOTE: Specifications subject to change without notice.

A.2 Receiver Characteristics

A.2.1 Input Signal Type & Frequency

GPS L1 C/A code, 1575.42 MHz

A.2.2 Timing Accuracy

Specifications apply at the 1 PPS output as of date of publication.

UTC/USNO ± 250 ns peak

less than ± 100 ns typical (SA off)

A.2.3 Internal Oscillator

The Model 1094B uses a high performance crystal synchronized to GPS time.

A.2.4 Position Accuracy

8 meters, rms, 90% confidence

A.2.5 Satellite Tracking

12 channel, C/A code (1575.42 MHz). Receiver simultaneously tracks up to twelve satellites.

A.2.6 Acquisition

- less than 5 minutes with current almanac
- less than 20 minutes without current almanac
- greater than 20 minutes in areas where antenna has limited or obstructed view of sky

A.3 I/O Configuration

A.3.1 Timed Outputs

Outputs: Four, each with BNC and 5-mm pluggable terminal strip in parallel. Output Select is jumper selectable between unmodulated IRIG-B, 1 Pulse Per Second (PPS), and Programmable Pulse. Output Mode is jumper selectable between 300 volt FET, modulated IRIG-B, and 5 Vdc (250 mA at > 4 V). Note that Programmable pulse is divided between Programmable Pulse A on outputs 1 and 2 and Programmable Pulse B on outputs 3 and 4. The MOSFET output is not electrically isolated from instrument common.

A.3.2 I/O Connectors

Each timing output has one BNC and 5-mm pluggable terminal strip in parallel. Event Input is BNC and DB-9M.

A.3.3 Standard Output Signals

- IRIG-B 003 and 000 (now 004), unmodulated
- IRIG-B 123 and 120 (now 124), modulated
- 1 PPS; Programmable Pulse
- 300 V FET switching

A.3.4 Input Functions

Input functions included one Event Input. Input connector is dedicated BNC or either of RS-232 connectors (COM1 and COM2).

A.3.5 Event Input Timing

For a received data message, the leading edge of the start bit may be selected to trigger the event input, providing synchronization with $0.1\mu\text{s}$ resolution.

A.4 SPDT Relay Specifications

- Type, SPDT, plastic encapsulated, sealed plastic construction
- Make/Model, OMRON/G6RN-1-DC5
- Rated switching current: 8 A @ 250 VAC and 5 A @ 30 VDC
- Max. switching capacity: 2,000 VA, 150 W
- Life expectancy: approx. 100,000 cycles/electrical, 10,000,000 cycles/mechanical
- Max. Frequency: approx. 360 operations/hour
- plastic sealed construction

A.5 Systems Interface

A.5.1 RS-232C COM1 and COM2

Connector: 9-pin D-type sub-miniature:

Pin No.	Function	Pin No.	Function
1	Not Connected	6	RS-232 Input
2	RS-232, Rx Data or Event Input	7	Not Connected
3	RS-232, Tx Data	8	RS-422/485, Tx-A
4	RS-232 Output/Prog Pulse	9	RS-422/485, Tx-B
5	Ground	–	–

Table A.1: COM1 and COM2 Pin Definitions

A.5.2 Communication Parameters

Selectable 1200, 2400, 9600, 19200, or 38400 baud; 7 or 8 data bits; 1 or 2 stop bits; odd/even/no parity. Supports all front-panel functions.

A.5.3 Broadcast Data Formats

Supports continuous output data in various formats. See Chapter 10, Serial Communication and Command Set (viz. Section 10.3.2).

A.5.4 Antenna System

The included antenna is weather proof and directly mounted on a 26 mm pole (1.05 in OD or 3/4 in ID pipe), with either a standard 1 in – 14 (approximately M25.4 x 1.81) marine-mount thread or a 3/4 in NPT pipe thread. Other mounting configurations are available (contact Arbiter Systems). Operates using 5 Vdc conducted through included antenna cable.

A.5.5 Antenna Cable

15 m 50 ft) cable included with antenna. Other cable styles and lengths available – see Table 4.2.

A.5.6 Operator Interface

RS-232C Interface or eight, front-panel keys

A.5.7 Setup Functions

See Chapter 7, The Setup Menus, for complete details on setting up the operation of the Model 1094B.

A.5.8 Display

2-line by 20-character, backlighted supertwist LCD

A.5.9 Display Functions

- Time: UTC or Local
- Position: Latitude, Longitude and Elevation
- Status: Clock, Receiver, EEPROM, Antenna
- 1-PPS (input) Deviation
- Event Time
- Configuration (four keys: SETUP, UP, DOWN, ENTER)

A.5.10 Annunciators - LEDs

- Operate (green)
- Stabilized (green)
- Unlocked (red)
- Fault (red)

A.6 Physical Specifications

A.6.1 Dimensions

Chassis: 430 mm W x 44 mm H x 280 mm D (16.9 in W x 1.7 in H x 11.0 in D)

Antenna: 77 mm Diameter x 66 mm Height (3.05 in Diameter x 2.61 in Height)

A.6.2 Weight

Clock: 1.9 kg (4.3 lbs) net. (instrument)

Antenna and Cable: 2.0 kg (4.4 lbs) net.

Shipping: 6.0 kg (13 lbs) net. (includes antenna, cables and accessories)

A.6.3 Power Requirements

Option 07 (RoHS) and Option 10 (RoHS)

Voltage: 85 Vac to 264 Vac, 47 Hz to 440 Hz, 20 VA max. or 110 Vdc to 350 Vdc, 15 W maximum

Option 08 (RoHS)

Voltage: 10 Vdc to 60 Vdc ONLY, 15 W maximum

A.6.4 Power Connector

Three-pole terminal strip and surge-withstand capability – Options 8 and 10

A.6.5 Electromagnetic Interference

- Conducted Emissions: power supply (Options 07 and 08) complies with FCC 20780, Class A and VDE 0871/6/78, Class A
- Surge Withstand Capability (SWC), power inlet (Options 08 and 10) designed to meet ANSI/IEEE C37.90-1 and IEC 801-4.

A.6.6 Temperature and Humidity

Temperature	Operate	Typical	Storage
Instrument	0 °C to +50 °C	−20 °C to +70 °C	−40 °C to +85 °C
Antenna	−40 °C to +85 °C	–	−55 °C to +100 °C
Antenna Cable	−40 °C to +75 °C	–	−40 °C to +80 °C

Table A.2: Specified Temperatures

Humidity: Non-condensing.

Appendix B

Using a Surge Arrester

B.1 Introduction

These instructions cover the installation of the Arbiter Systems Model AS0094500, Surge Arrester/ Grounding Block. The AS0094500 performs two basic functions:

1. Provides a solid and reliable grounding point for the antenna system connected to a GNSS receiver;
2. Protects connected equipment from the damaging effects of atmospheric static electricity and induced voltage spikes from nearby lightning strikes or other electrical events.

B.2 Description

The Model AS0094500 is a three-terminal device with two type F connectors and one ground terminal. The type F connectors are interchangeable. One connects to the antenna and the other connects to the receiver. A screw terminal provides a connection point for an earth ground wire. The arrester is weatherproof and may be mounted outdoors provided that the cabling and type F connectors are sealed from the weather. The arrester also passes dc power to energize the antenna.

B.3 Installation

B.3.1 Mounting Location

Location is a key consideration when installing the Model AS0094500. It should be mounted as close as possible to a good earth ground, such as a grounding rod or station ground grid. The shorter the path between the arrester and the earth ground, the more effectively it will bypass the induced voltages.

B.3.2 Ground Connection

The Model AS0094500 may be grounded in two ways: (1) via the ground-wire screw connection, or (2) by hard-mounting directly to a grounded metal surface.

If grounding via the ground-wire screw connection, use the largest possible gauge wire. Hole diameter allows up to 8 AWG wire (0.129 in or 3.26 mm). This wire should be as short as possible, and connected to a good earth ground.

Alternately, the arrester may be mounted directly to a well-grounded plate within the facility

B.3.3 Antenna and Clock Connections

The type F connectors are interchangeable. One connects to the antenna and the other connects to the receiver. Use only a low-loss, tri-shield or quad-shield 75-ohm coaxial cable – RG-6 or RG-11 are the preferred cable types. RG-59, or other similar types of coaxial cable, should be avoided due to greater signal loss and poorer shielding at the GNSS frequency (1.575 GHz).

B.3.4 Weather Sealing the Connections

To protect from weather, use only type F connectors with appropriate sealing features. Typically this includes an o-ring in the male connector that seats against the face of the female connector on the surge arrester. Also, crimped connectors frequently include a silicone gel flooding compound, which enhances the ability of the connection to withstand the rain and humid conditions. To better seal the entire connection, cover the joint with GE Silicone II compound.

Use the proper crimping tool if using crimp-on connectors. Improper tools may not guarantee a strong and sufficiently grounded connector resulting in poor cable performance and GNSS reception. Consider purchasing RF cables of various standard and custom lengths manufactured by Arbiter Systems.

B.3.5 Suggested Mounting

Figure B.1 illustrates the recommended mounting of the AS0094500 with the F-connectors facing downward. Install drip loops in the cables to reduce the likelihood of moisture penetrating the device and the structure.

B.4 Physical Dimensions

Overall:	59 mm × 38 mm × 18 mm (2.32 in × 1.49 in × 0.71 in) L x W x H
Mounting Hole Dim:	50 mm × 15 mm
Mounting Hole Dia:	4 mm (0.157 in)
F Connector Dim:	24 mm, center to center
Weight:	48.2 g (1.7 oz)

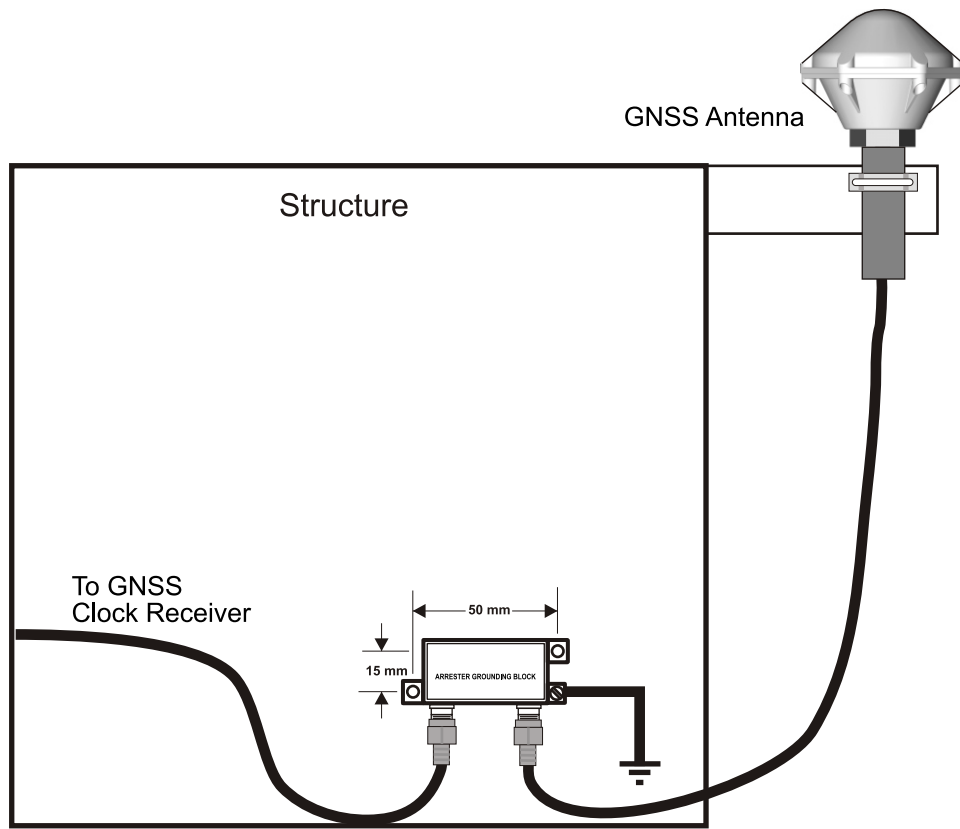

Figure B.1: Suggested Mounting of the AS0094500

Appendix C

Statement of Compliance

C.1 Introduction

The following page is a statement of compliance that includes Model 1094B.

G.P.S. Satellite Clock Statement of Compliance

February 5, 2008

TO WHOM IT MAY CONCERN:

All Arbiter Systems, Incorporated G.P.S. Satellite Controlled Clocks are Primary Standards. They provide time traceable to U.T.C. and U.S.N.O. within published accuracy specifications anywhere in the world. All Arbiter Systems Incorporated G.P.S. Satellite Controlled Clocks also carry a limited lifetime warranty, which is based on in field MTBF (Mean Time Between Failures) of over one million (1,000,000) hours. These products are available with all known time synchronization signals presently in use world wide by the electric power industry.

Arbiter Systems does not supply a type test certificate as requested for G.P.S. systems as the accuracy is a function of the G.P.S. system and not of the receiver. However we (Arbiter) hereby certify that this equipment conforms to all Arbiter Systems Incorporated specifications for material and process. All Arbiter Systems calibration products are supplied with a type test certificate guaranteeing traceability to National Standards, but are inappropriate for G.P.S. clocks, which are Primary Standards by definition.

Regards,

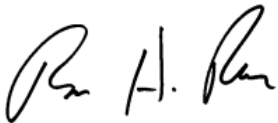

Bruce H. Roeder
International Marketing Manager
Arbiter Systems, Inc.
BHR/sc

Appendix D

Switching High Voltage Signals

D.1 Introduction

This section provides information on switching high voltage signal lines (up to 300 Vdc) from Outputs 1 – 4. Outputs 1 – 4 can be configured as either 5 V_{CMOS} output or a 300-Volt FET pull down. Depending on grounding and isolation requirements, it may be necessary to isolate the connection between the clock output and the external equipment using a small switching relay. Several examples follow to illustrate logging applications.

D.2 Example 1: 300-Volt FET Pull Down

Figure D.1 illustrates one method of connecting the 300-Volt FET for a pull down event logging application. Use this method with applications when it is acceptable to connect the negative side of the FET to the 1094B chassis ground. This application could also be used with a periodic programmable pulse (e.g. 1 Pulse Per Minute) for timing instead of event logging.

FET Specifications

- $V_{DSS} = 400$ V, max drain-source voltage
- $R_{DS(on)} = 0.55$ Ω , max drain-source resistance
- $I_d = 10$ A, max continuous drain current (@ 25°C)
- $P_D = 3.1$ Watts, max power dissipation

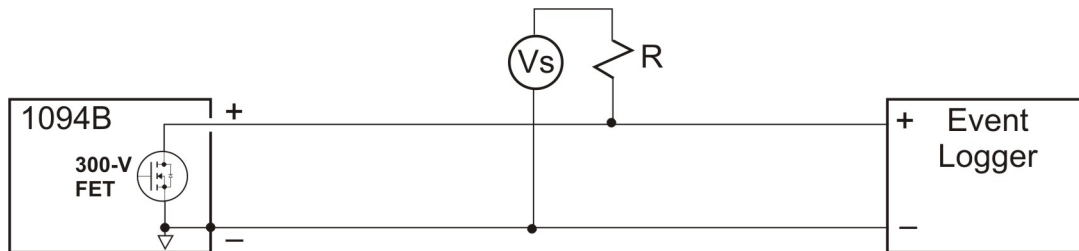

Figure D.1: 300-Volt FET with Pull-Down Resistor

D.2.1 Logging Requirements and Circuit Notes

To log an event, the Event Logger must “see” the rising edge of a pulse from 24 to 48 volts. When the pulse clears, or returns to zero, it will be ready to record another event. The connections in Figure D.1 are between the 300-Volt FET and the Event Logger. A 48-volt supply is connected across the lines between the clock and the event logger with a 4.7 k ohm resistor in the positive supply line. This limits the FET current to approximately 10 milliamperes. Configure the Model 1094B by setting up for a negative Pulse Polarity so that the FET is turned on and the voltage Logger + side is held low. When the pulse occurs, the FET will turn off and the + line will rise to the battery voltage and return to zero when the pulse clears.

D.3 Example 2: 300-Volt FET with Voltage Source in Series

Figure D.2 illustrates another method of connecting the 300-Volt FET for a pull down event logging application, however the voltage source is in series with the FET. Such would be the case if the event logger had an opto-isolator detector and registered an event with application of current through the opto-isolator. This would correspond with the FET in the ‘ON’ state, so pulse configuration would be “Positive.”

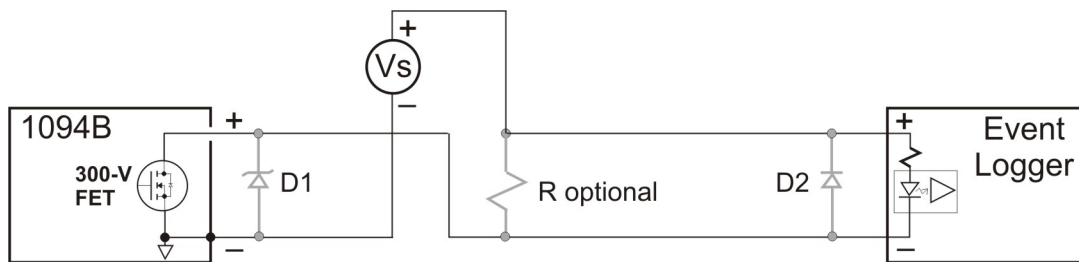

Figure D.2: 300-Volt FET with Voltage Source in Series

D.3.1 Logging Requirements and Circuit Notes

To log an event, the FET must be switched “ON,” which causes a current to flow through the large circuit, including the Event Logger. The opto-isolator detects the current and the event is recorded until the FET switches “OFF,” and the current subsides in the opto-isolator. D1 is an optional zener diode to protect against voltage spikes smaller than would be protected by the internal diode in the FET. This diode would be chosen specifically from the given application. D2 is a reverse protection diode (e.g. 1N4001) to protect the opto-isolator. R is a pull-down resistor also scaled to the application.

D.3.2 Configuring for 300-Volt FET Pull Down

The chosen output needs to be configured for 300V FET using Programmable Pulse A or Programmable Pulse B mode. For jumper selection of the individual outputs, see Table 5.2 and Section 5.2.1. For Output 1 and 2, use Programmable Pulse A; for Outputs 3 and 4 use Programmable Pulse B. As an example, for Output 1, set JMP10 to C and JMP11 to A.

Configure the programmable pulse through the front panel using the SETUP key or by using 1094 Utility application. Both methods allow you full selection of all programmable pulse features. From the front panel, see Section 7.9, and using the 1094 Utility, see Section 6.6.8 or Section 6.6.9.

D.4 Example 3: 5 Volt Switching with External Relay

Figure D.3 illustrates the connection between the the Model 1094B and the logger, with intermediate switching relay. As mentioned in the introduction, some applications may require a positive ground, or method to isolate the recorder or event logger from the Model 1094B. To accomplish this, it is simple to place a small switching relay between the clock output and the event logger. Since the application requires a positive ground, the small relay isolates the clock from the event logger.

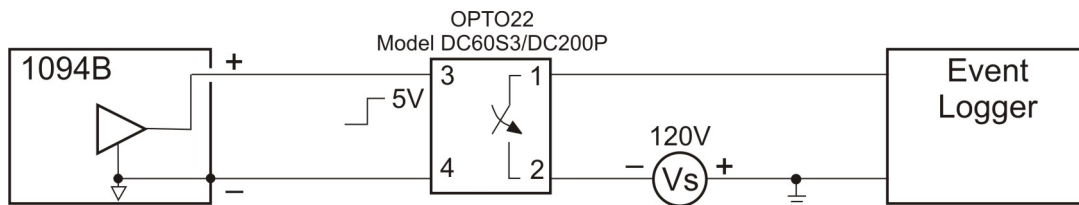

Figure D.3: 5 Volt Switching with Isolation Relay

D.4.1 Configuring for 5-Volt CMOS

The chosen output needs to be configured for 5V CMOS and Programmable Pulse. Therefore, for Output 1, set JMP10 to C and JMP11 to C. Outputs 2, 3 and 4 would be set similarly.

Index

- 1-PPS
 - description, 67
- 1094B software
 - connecting, 34
 - display setup, 44
 - opening configuration file, 45
 - prog pulse A, 42
 - prog pulse B, 43
 - reading clock config, 36
 - saving configuration file, 45
 - serial parameters, 39
 - system parameters, 37
 - time adjustment, 40, 41
 - upload warning, 45
 - uploading new firmware, 45
 - USB-to-Serial adapters, 35
- 300-Volt FET, 110
 - protection, 68
 - setup, 68
- accessories
 - included, 1
- accessory cables, 20
- altitude, see elevation display
- analog drivers, 65
- antenna
 - checking resistance, 18
 - clock connection, 21
 - connection, 15, 21
 - installation, 15
 - mounting assembly, 16
 - mounting kit, 15, 16
 - mounting procedure, 16
 - power supplied to, 21
 - user-supplied cables, 21
 - voltage, 18
 - voltage check, 18
- antenna & cable testing, 18
- antenna cable
 - effects of cable parameters, 19
- Appendix
 - A, 100
 - D, 108
 - E, 110
- cable
 - accessory, 20
 - adjacent signal interference, 21
 - attenuation, 20
 - DC resistance, 20
 - delay, 19
 - delays, 71
 - distance, 69
 - physical protection, 20
 - timing output, 69
 - user-supplied, 21
 - wire losses, 70
- caution, see precautions
- COM Port
 - identifying, 35
 - reassigning number, 35
- comm ports, 79
- command key
 - definitions, 5
- configure
 - Backlight, 53
 - begin, 48
 - Cable Delay, 54
 - com ports, 49
 - Daylight Saving, 52
 - Event Inputs, 63
 - firmware setup, 47
 - IRIG-B, 61
 - Local Offset, 51
 - Out of Lock, 53
 - programmable pulse, 55
 - Summertime, 52

- Survey Mode, 62
- configure clock
 - COM parameters, 39
 - connect, 34
 - display, 44
 - IRIG-B, 41
 - open new configuration, 45
 - prog pulse A, 42
 - prog pulse B, 43
 - read configuration, 36
 - save config file, 45
 - system, 37
 - time adjustment, 40
 - tutorial, 33
 - usb-to-serial adapter, 35
 - Windows device manager, 35
- configuring
 - Jumpers
 - output, 23
- connecting
 - modulated IRIG-B, 70
 - outputs, 69
 - relay contacts, 74
 - unmodulated IRIG-B, 69
- connecting power to the clock, see inlet power
- connector
 - antenna, 8, 15
 - event input, 9
 - power inlet, 7
 - relay contacts, 9
 - serial communications, 9
 - timing output, 10
- Contact Information, ii
- copyright, v
- cordsets
 - IED-320 power inlet connector (RoHS), 12
- custom broadcast
 - return string, 82
 - string command, 81
 - string setup, 80
- Daylight Saving Time, 40
- defaults
 - resetting to, 44
- deviation
 - measurement, 75
 - measurement principle, 75
- digital drivers, 65
- display
 - startup, 28
- display modes
 - Position, 32
 - Time, 30
- drive current vs. output voltage, 65
- driver
 - analog, 65
 - digital, 65
- elevation display, 32
- event channel
 - programming, 26
 - setup, 25
- event display indication, 29
- event inputs, 74
 - allowable input voltage, 25, 26
 - channel configuration, 75
 - clearing all events, 77
 - displaying data, 76
 - event format, 76
 - introduction, 74
 - number of records, 76
 - timing principle, 74
- events
 - clear event buffer, 38
- factory defaults
 - resetting to, 44
- fault
 - conditions, 73
 - viewing, 73
- fault indication, 5
- fault modes, 30
- Firmware updates, ii
- front panel drawing, see panel drawing, front
- fuses
 - replacing, 14
 - types and location, 13
- gps
 - surge arrester, 18, 105
- handling
 - precautions, 1

- humidity, 104
- IEC-320 power inlet connector (RoHS), 7
- initial clock time, 27
- initial LED indication, 27
- initial startup sequence, 27
- inlet power, 11
- IRIG-B
 - IEEE 1344 description, 67
 - initial indication, 30
 - modulated
 - voltage matching, 71
 - timecode description, 66
 - waveform comparison, 67
- IRIG-B Time code types, 66
- jumpers
 - configuring
 - communication, 24
 - event input, 25
 - output, 23
 - relay contacts, 24
 - mainboard, list of functions, 23
- keys
 - description, 5
 - Down, 6
 - Enter, 7
 - Event/Deviation, 6
 - Position, 6
 - Setup, 6
 - Status, 6
 - Time, 6
 - Up, 6
- latitude display, 32
- LCD
 - display, 5
- LED
 - annunciator
 - definitions, 5
- longitude display, 32
- mounting kit
 - antenna, 15
- numeric data entry mode, 48, 54
- open drain, see 300-Volt FET
- Option
 - 08, terminals with SWC (RoHS), 8
 - 10, terminals with SWC (RoHS), 8
- Options
 - 07, IEC-320 connector (RoHS), 7
 - power, 07 (RoHS), 11
 - power, 08 (RoHS), 12
 - power, 10 (RoHS), 13
- output signal
 - description, 66
- panel
 - rear
 - description, 64
- panels
 - drawing
 - front, 4
 - rear, 7
 - front, 4
 - rear, 4
- position display modes, 32
 - datum, 32
- precautions, 1
- programmable pulse, see configure
 - Aux IRIG Mode, 60
 - description, 68
 - Frequency Mode, 60
 - preliminary setup values, 56
 - pulse width, 68
 - Pulse-Per-Day Mode, 58
 - Pulse-Per-Hour Mode, 57
 - Pulse-Per-Minute Mode, 57
 - Pulse-Per-Second Mode, 56
 - Seconds-Per-Pulse Mode, 59
 - Single Trigger Mode, 58
 - Slow Code Mode, 59
- rack mount
 - ears, 2
 - mounting instructions, 2
- rear panel, see panel, rear
- relay contacts
 - connecting, 74
 - connector, 9
 - functions, 73
 - modes, 24

- specifications, 24, 102
- ROM date, ii
- RS-232C Communication, see serial command
- serial command
 - antenna delay
 - set, 98
 - broadcast
 - interrogate, 84
 - ABB, 87
 - ASCII + Quality, 86
 - ASCII Std, 84
 - custom, 81
 - Display Screen, 88
 - Event Data, 84
 - Extended ASCII, 85
 - Kissimmee, 88
 - NGTS, 89
 - NMEA183 GLL, 86
 - NMEA183 ZDA, 87
 - Philippe, 88
 - Status, 85
 - Vorne Std, 84
 - Year + ASCII, 86
 - broadcast strings, 83
 - DST/Summertime
 - activate, 92
 - return settings, 92
 - start time, 93
 - stop time, 93
 - Event
 - channel time, 90
 - control operation, 90
 - return deviation, 90
 - Event number, 90
 - front panel backlight control, 93
 - Local Offset, 93
 - out-of-lock alarm
 - set time, 98
 - Prog Pulse
 - pulse delay, 97
 - pulse frequency, 98
 - pulse polarity, 97, 98
 - set mode, 96
 - set pulse width, 96
 - set time mark, 97
 - return
 - display buffer, 99
 - firmware version, 98
 - local date, 95
 - local time, 96
 - UTC date, 96
 - UTC time, 96
 - return elevation, 94
 - return longitude, 95
 - set
 - com settings, 83
 - display mode, 99
 - receiver position, 95
 - set IEEE 1344 mode, 94
 - set receiver time, 95
 - Status
 - clock, 91
 - EEPROM, 91
 - receiver, 91
 - status of event/deviation, 91
 - time quality, 92
 - survey mode, 99
- serial port
 - output symbols, 80
 - pin definitions, 79, 102
- Setup menu list, 47
- signal
 - output
 - description, 66
- software
 - see1094B software, 33
- specifications, 100
 - accuracy, 100
 - acquisition, 101
 - annunciator LED's, 103
 - antenna cable, 102
 - antenna system, 102
 - dimensions, 103
 - display, 103
 - display functions, 103
 - electromagnetic interference, 104
 - event timing, 101
 - GPS receiver, 100
 - I/O connectors, 101
 - input functions, 101
 - operator interface, 103

- oscillator, 100
- position accuracy, 100
- power connector, 104
- power requirements, 104
- satellite tracking, 100
- serial port parameters, 102
- serial port pinout, 102
- serial ports, 102
- setup functions, 103
- standard output signals, 101
- temperature and humidity, 104
- timing outputs, 101
- weight, 103
- startup sequence, 27
- Statement of Compliance, 108
- status display indication, 29
- surge arrester, 18, 105
- synchronizing
 - multiple devices on one port, 69
- temperatures, 104
- time display modes, 30
- timing outputs
 - description, 64
 - intro, 64
- title page, v
- unpacking the clock, 1
- warranty, iii
- WGS-84, 32